

**RADAR AND NAVIGATION AIDS**

- RADAR means Radio Detection and Ranging. It is a device which can detect the presence of Target and measure its Range.
- Radar is an electromagnetic system for detection and location of reflecting objects such as aircrafts, ships, vehicles, people and natural environment etc.
- It operates by transmitting a particular type of wave form (for e.g. pulse modulated sine wave) into space and detects the nature of echo signal reflected from an objects or targets.
- Radar can't recognize colour of objects but it can recognize darkness, fog, smoke, rain, snow etc.

**☛ SIMPLE RADAR SYSTEM:-**

- A Simple Radar System consists of Transmitter, Receiver and Antenna.
- A Transmitter generates an EM Signal which is radiated into space by Transmitting Antenna. A portion of the transmitted energy is intercepted by the target and re-radiated in many directions. The radiation directed towards the Radar is collected by the receiving Antenna and delivers into receiver.
- At the receiver the Signal is processed to detect the presence of target and determines its location.
- A Single Antenna is generally used in a time shared basic for both

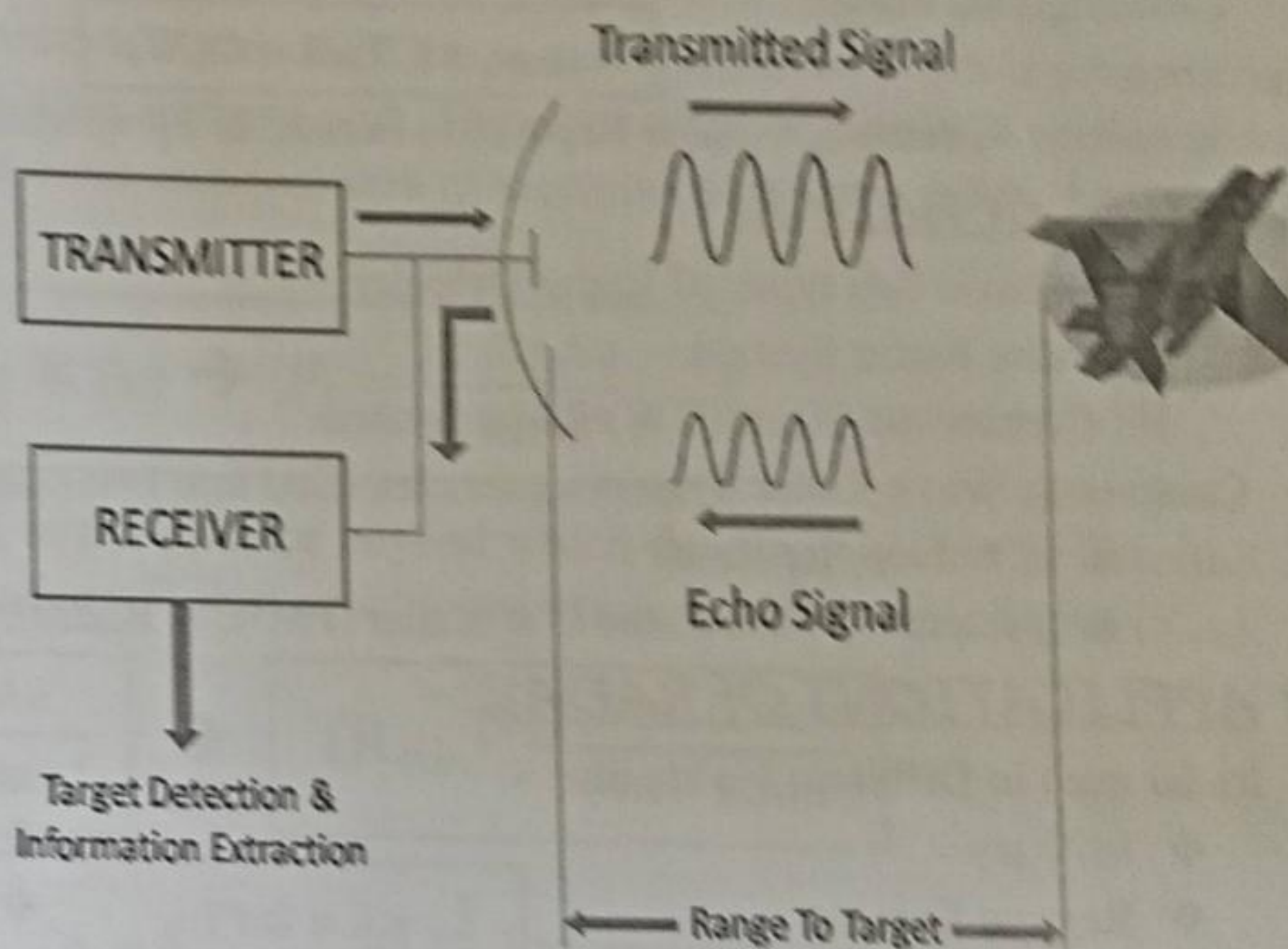

[ BLOCK DIAGRAM OF A SIMPLE RADAR SYSTEM ]

- Transmitting and Receiving when the radar waveform is a repetitive series of pulses.
- The range or distance to a target is found by measuring the time it takes for the radar signal to travel to the target and return back to the Radar.
- Radar can also provide information about nature of target being observed.
- If the target is in motion, there is a shift in the frequency of the echo signal due to the Doppler Effect. This frequency shift is proportional to the velocity of the target related to the Radar which is known as Radar velocity.
- ☉ **NOTE:** Doppler frequency shift is widely used in Radar as the basic for separating desired moving target from fixed(Unwanted) clutter echoes reflected from natural environments such as sea, Lake Etc.
- The range of the target is determined by the time  $T_R$ ; It is the time taken by the pulse to travels to the target and returns back.
- The EM Wave in the space travel in the speed of light i.e.  $3 \times 10^8$  m/s. Thus the time taken for the signal to travel to the target located at a Range 'R' and returned back to the Radar can found as: -

$$V=S/T \Rightarrow T=S/V$$

$$T_R=2R/C \rightarrow R=CT_R/2 \quad [V \equiv \text{Velocity} \equiv C; S \equiv \text{Distance} \equiv R; T \equiv \text{Time} \equiv T_R]$$

**NOTE:-**

$$R_{KM} = 0.15 T_R (\mu s) \quad R_{Mtr} = 150 T_R (\mu s) \quad R_{Yard} = 164 T_R (\mu s) \quad R_{Feet} = 492 T_R (\mu s)$$

$$R_{nmi} = 0.081 T_R (\mu s) \quad [nmi = \text{Nautical Miles}] \quad R_{smi} = 0.081 T_R (\mu s) \quad [smi = \text{Statute Miles}]$$

**Un-Ambiguous Range:-**

- Once the signal is radiated into space by Radar, Sufficient time must elapse to allow all echo signals to return to the Radar before the next pulse is transmitted. The rate at which the next pulse transmitted is determined by the longest range at which targets are accepted.
- If the time between pulses  $T_p$  is too short an echo signal from long range target might arrive after the transmission of next pulse and we mistakenly associated with that pulse rather than the actual pulse transmitted earlier. This can result an incorrect or ambiguous measurement of Range.
- Echo that arrives after the transmission of next pulse are called second-time around echo. Such an echo would appear to be at a closer range than the actual and its range measurement is called misleading, if it were not known to be second-time around echo.
- Hence the range beyond which the target appears as second-time around echo is called Maximum Unambiguous Range.

$$R_{Unamb} = CT_p/2 = C/2F_p$$

Where,  $T_p$  = Pulse Repetition Period. &  $F_p$  = Pulse Repetition Frequency.

**TYPES OF RADAR:-**

- There are basic two types of Radar Detector
  - ☐ Pulse Radar System
  - ☐ Contineous Wave (CW) Radar System
- Continuous Wave Radar System again classified into two categories such as: -
  - ⊙ CW Doppler Radar
  - ⊙ Frequency Modulated CW Radar (FM-CW Radar).

**APPLICATIONS OF RADAR:-**

- Radar used in Different Fields like: -
  - ❖ Military
  - ❖ Highway Safety
  - ❖ Remote Sensing
  - ❖ Aircraft Safety and Navigation
  - ❖ Air Traffic Control
  - ❖ Ship Safety
  - ❖ Law Enforcement
  - ❖ Space Vehicles Control etc.

**Performance Factors of RADAR (OR) Radar Range Equations:-**

- Radar Equation relates the Range of Radar to the characteristic of Transmitter, Receiver, Antenna, Target, and Environment etc.
- It is used not just as a man for determining the maximum distance from Radar to a Target. But it can serve both as a tool for understanding Radar Operation and a Basic form of Radar Design.
- In this section the simple form of Radar Equation is derived.
- For an isotropic antenna; If the Power of Radar Transmitter is denoted by  $P_t$  then the Power Density (watts per unit area) at a distance 'R' is equal to the Transmitted Power Divided by the Surface Area ( $4\pi R^2$ ) of an Imaginary Sphere with Radius 'R'. Where  $P_i$  = Power Density from Isotropic Antenna.

$$P_i = \frac{P_t}{4\pi R^2} \dots\dots\dots (1)$$

- Generally Radar uses Directive antennas to channels. In this case the radiated power  $P_t$  is in some particular direction. If the gain (G) of an antenna is a measure of increased power radiated in the direction of target as compared with power that would have been radiated. And is defined as,

$$G = \frac{\text{Maximum Power Density Radiated by Directive Antenna}}{\text{Power radiated by a loss less Isotropic Antenna with same Power Input}}$$

- So, The Power Density at the target form an Directive Antenna with a transmitting gain 'G' is

$$\mathcal{P}_D = \frac{P_t G}{4\pi R^2} \dots\dots\dots (2)$$

- The target intercepts a portion of radiated power and re-radiated it in the various directions. The measure of the amount of incident power intercepted by the target and re-radiated back in the Radar Cross Section ( $\sigma$ ) and is defined by the relation.

$$\text{Power Density of the echo signal at Radar} = \frac{P_t G}{4\pi R^2} \times \frac{\sigma}{4\pi R^2} = \frac{P_t G \sigma}{(4\pi R^2)^2} \dots\dots\dots (3)$$

- The Radar cross section ( $\sigma$ ) as unit of area, it is the characteristic of a particular target and a measure of its size as seen by the Radar.
- Like target the Receiving Antenna intercepts a portion of the re-radiated power which is proportional to the Cross Sectional Area of the Receiving Antenna ( $A_e$ ). The radar antenna captures a portion of the echo power. If the effective area of the cross sectional area of receiving antenna is denoted as  $A_e$ . The power receiving by the Radar is

$$\mathcal{P}_r = \frac{P_t G}{4\pi R^2} \times \frac{\sigma}{4\pi R^2} \times A_e \rightarrow \mathcal{P}_r = \frac{P_t G \sigma A_e}{(4\pi)^2 R^4} \dots\dots\dots (4)$$

- The Maximum Radar Range i.e.  $R_{max}$  is the distance beyond which the target cannot be detected. It occurs when the received echo signal power  $\mathcal{P}_r$  just equal to the Minimum Detectable Signal ( $S_{min}$ ),

$$S_{min} = \frac{P_t G \sigma A_e}{(4\pi)^2 R_{max}^4} \rightarrow (R_{max})^4 = \frac{P_t G \sigma A_e}{(4\pi)^2 S_{min}}$$

$$\Rightarrow (R_{max}) = \left[ \frac{P_t G \sigma A_e}{(4\pi)^2 S_{min}} \right]^{\frac{1}{4}} \dots\dots\dots (5)$$

- That is the Fundamental of the Radar Equation.
- NOTE:** - The important antenna parameters are Transmitting Gain & the Receiving Effective Area.
- Antenna theory give the relation between Transmitting gain & receiving affective area of antenna i.e.,

$$G = \frac{4\pi A_e}{\lambda^2} \quad \& \quad A_e = \frac{G \lambda^2}{4\pi} \dots\dots\dots (6)$$

- Since the Radar generally use the same antenna both for Transmission and Reception, So we use these values in fundamental equation of Radar.

$$R_{max} = \frac{P_t 4\pi A_e}{\lambda^2} \times \frac{A_e \sigma}{(4\pi)^2 S_{min}} \Rightarrow R_{max} = \left[ \frac{P_t A_e^2 \sigma}{4\pi \lambda^2 S_{min}} \right]^{\frac{1}{4}} \dots\dots\dots (7)$$

$$R_{max} = \left[ \frac{P_t \left(\frac{G \lambda^2}{4\pi}\right)^2 \sigma}{4\pi \lambda^2 S_{min}} \right]^{\frac{1}{4}} \quad \& \quad R_{max} = \left[ \frac{P_t G^2 \lambda^2 \sigma}{(4\pi)^3 S_{min}} \right]^{\frac{1}{4}} \dots\dots\dots (8)$$

- These simplified versions of Radar equation don't adequately describe the performance of actual Radars, as many important factors are not included. Also Idealized conditions have been employed i.e. neither the Effect of Ground nor Absorption and Interference is taken into account. Hence, the maximum range in practice is often less than that of indicated by the Radar Range Equation.

## **PULSE RADAR SYSTEM:-**

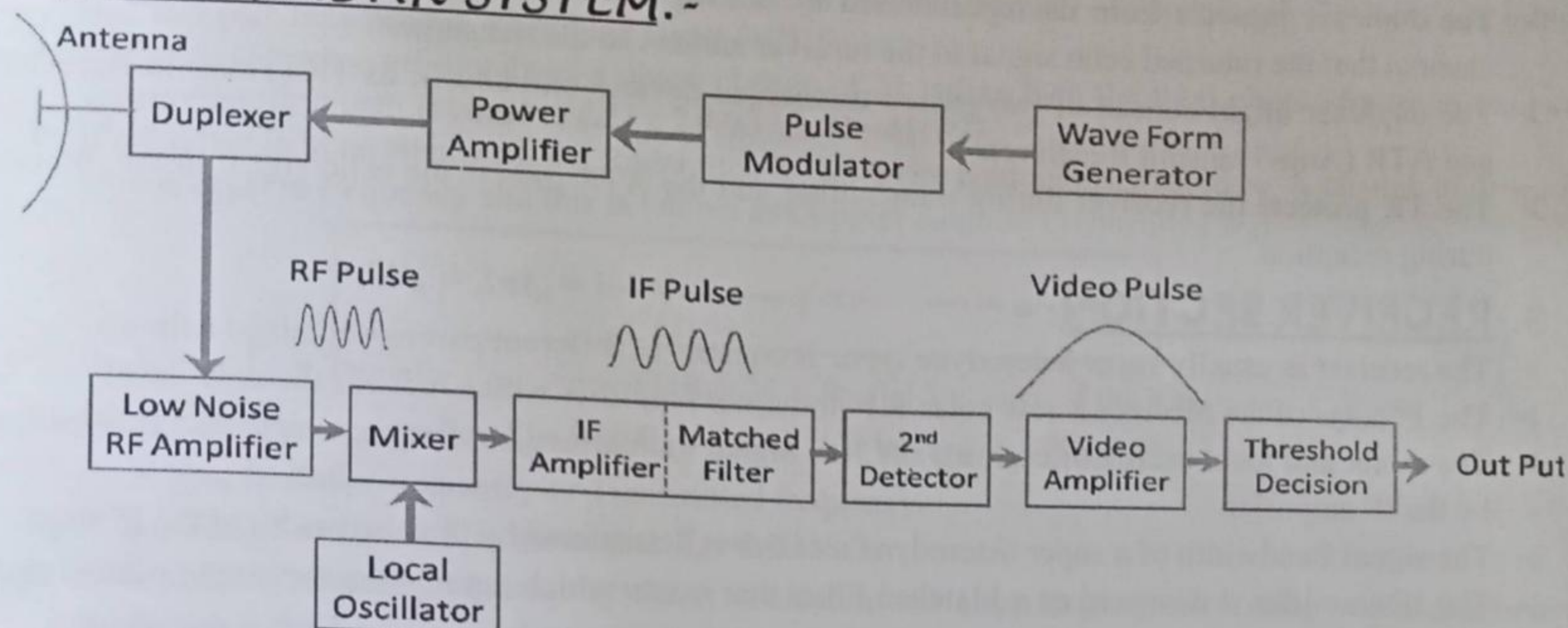

[ BLOCK DIAGRAM OF A PULSE MODULATED RADAR SYSTEM ]

- The operation of a typical Pulse Radar System is described by the help of block diagram.
- Generally it consists of Antenna, Transmitter and Receiver which are explained below.

### 1. ANTENNA: -

- The function of antenna during transmission is to concentrate the radiated energy into a shaped beam which points in the desired direction in the space.
- On reception the antenna collects energy contained in the echo signal and delivers it to the receiver.
- The two important input parameters of Antenna i.e. Transmitting Gain (G) and Effective Receiving Area ( $A_e$ ) are proportional to each other.
- An antenna with large effective receiving aperture implies a large transmitting gain.
- Different type of antenna can be used in Radar such as mechanically steered parabolic reflector, electrically steered planned array antenna or electrically steered phase array antenna etc.

### 2. TRANSMITTER: -

- The Transmitter may be an oscillator such as a Magnetron i.e. pulsed [turned ON and OFF] by the modulator to generate a repetitive train of pulse.
- The Magnetron most widely used for a various microwave generator for Radar.
- A Typical Radar for the detection of aircraft has the following points: -
  - ☐ Ranges nearly equal to 100 to 200nmi.
  - ☐ Transmitting power in the order of mega watt & Average power in order of several kilowatt;
  - ☐ Pulse Width in the order of micro second.
  - ☐ Pulse repetition frequency in the order of several 100 pulses per sec.
- Transmitting section consists of Waveform Generator, Pulse Modulator, Power Amplifier & Duplexer.
- The waveform generator generates repetitive train of pulse & is fed to pulse modulator for modulation.
- The pulse modulator modulates the train of pulses and gives the pulse modulated signal to the power amplifier for amplification.
- The power amplifier amplifies the pulse modulated signal and fed to the duplexer. Generally audio frequency amplifier is used for this purpose.
- The duplexer allows a single antenna to be used on a time sharing basis for transmitting and receiving.
- The duplexer is generally a gaseous device that produces a short circuited at input to the antenna During Transmission. So that the high power is flows to the antenna not to the receiver.

- The duplexer protects from damages caused by the high power of the transmitter. It also serves to channel that the returned echo signal to the receiver and not to the transmitter.
- The duplexer might consist of two gassed discharged devices one known as TR (Transmit Receiver) and ATR (Anti-Transmit Receiver).
- The TR protects the receiver during transmitting and the ATR directs the echo signal to the receiver during reception.

### 3. RECEIVER SECTION: -

- The receiver is usually super heterodyne type. It consists of different part as explained bellow: -
- The 1<sup>st</sup> stage of the receiver is low noise R.F. transistor amplifier which reduces the noise level.
- The mixer and local oscillator converts the R.F. signal to intermediate frequency where it is amplified by the IF amplifier.
- The signal Bandwidth of a super heterodyne receiver is determined by the bandwidth of the IF stage.
- The IF amplifier is designed as a Matched Filter that is one which maximizes the output peak-signal-to-mean-noise ratio.
- Thus the basic function of matched filter is to maximize the detectability of weak echo signal & attenuates the unwanted signal.
- The IF amplifier is followed by a critical diode which is called the second detector or demodulator. Its purpose is to assist extracting the modulating signal from the modulated signal.
- The combination of IF amplifier, 2<sup>nd</sup> detector and video amplifier act as an envelope detector to pass pulse modulation (envelop) and reject the carrier frequency.
- To detect the Doppler shift of the echo signal the enveloped detector replaced by phase detector which is different from the envelope detector.
- The combination of the IF amplifier and video amplifier is designed to provide sufficient amplification or gain to raise the level of the input signal to a magnitude where it can be seen in a display.
- At the end of the receiver a decision is made whether a target is present or not. The decision is based on the magnitude of the receiver output.
- If the output is large enough to exceed a pre-determined threshold, the decision is that the target is present. If it does not cross the threshold only noise is assumed to present.
- The display unit is usually a Cathode Ray Tube; the most common form of the CRT is Plane Position Indicator (PPI) which maps location of the target is in Azimuth angle & Range in polar co-ordinates.
- B-scope display is similar to the PPI except that it utilizes the rectangular co-ordinate rather than the polar co-ordinates to display Range Vs Angle.
- Another for display is A-scope which plots target Amplitude Vs Range for some fixed direction.

### 📡 CONTINUOUS WAVE RADAR (CW RADAR) :-

- Pulse Radar is used for detection of Stationary Objects; Where as to detect a Moving Target, continuous wave type of Radar is used.
- CW Radar is of Two type: -
  - (1) CW Doppler Radar
  - (2) FM CW Radar
- CW Doppler Radar uses the Doppler Effect for the Target Speed Measurement.
- FM CW Radar is used to measure Range as well as Velocity of the Target.

### ❖ DOPPLER EFFECT:-

- The aperant frequency of electromagnetic or sound waves depends on the relative radial motion of the source or observer. If the source and observer one moving away from each other then the aperant frequency will decrease and when they moving towards each other then the aperant frequency will increase. This phenomenon was postulated by C. Doppler. So it is known as **Doppler Effect**.

- If 'R' is the distance from the Radar to target then the total number of wavelength ( $\lambda$ ) contained in the two way path between the Radar and target is  $2R/\lambda$ .
- Each wavelength corresponds to a phase change of  $2\pi$  radian then the total phase change in the two way propagation path is equal to  $(2\pi \times 2R/\lambda)$  i.e.  $\Phi = 4\pi R/\lambda$ .
- If the target is in motion w.r.t. the Radar then R and  $\Phi$  are continuously changes. A change in  $\Phi$  w.r.t. time is equal to frequency and this is known as Doppler Angular Frequency ( $\omega_d$ ).

$$\omega_d = 2\pi f_d = \frac{d\Phi}{dt} = \frac{d(4\pi R/\lambda)}{dt} = \frac{4\pi}{\lambda} \frac{dR}{dt} = \frac{4\pi}{\lambda} V_r$$

Where  $f_d$  = Doppler Frequency Shift &  $V_r$  = Radial Velocity of the Target w.r.t. Radar

- From the above expression,  $f_d = 2V_r/\lambda$ . Put  $\lambda = c/f_t$ , We get  $f_d = 2V_r f_t / c$ .

Where  $f_t$  = Radar frequency or Transmitted frequency.

- If  $f_d$  in Hz,  $V_r$  in m/s &  $\lambda$  in meter then  $f_d = 1.03 V_r f_t / \lambda$ .

- ⊙ With a CW Transmit frequency of 5GHz, Calculate the Doppler frequency seen by the Stationary Radar when the Target radial velocity is 100km/hr.

Given that  $f_t = 5 \text{ GHz} = 5 \times 10^9 \text{ Hz}$ ;  $V_r = 100 \text{ Km/hr} = 100 \times 1000 / 3600 = 27.8 \text{ m/s}$ ;  $c = 3 \times 10^8 \text{ m/s}$ .

As  $\lambda = c/f = (3 \times 10^8) / (5 \times 10^9) = 0.06 \text{ m}$

$f_d = 2V_r / \lambda = (2 \times 27.8) / 0.06 = 926 \text{ Hz}$ .

### 1. CW Doppler RADAR:-

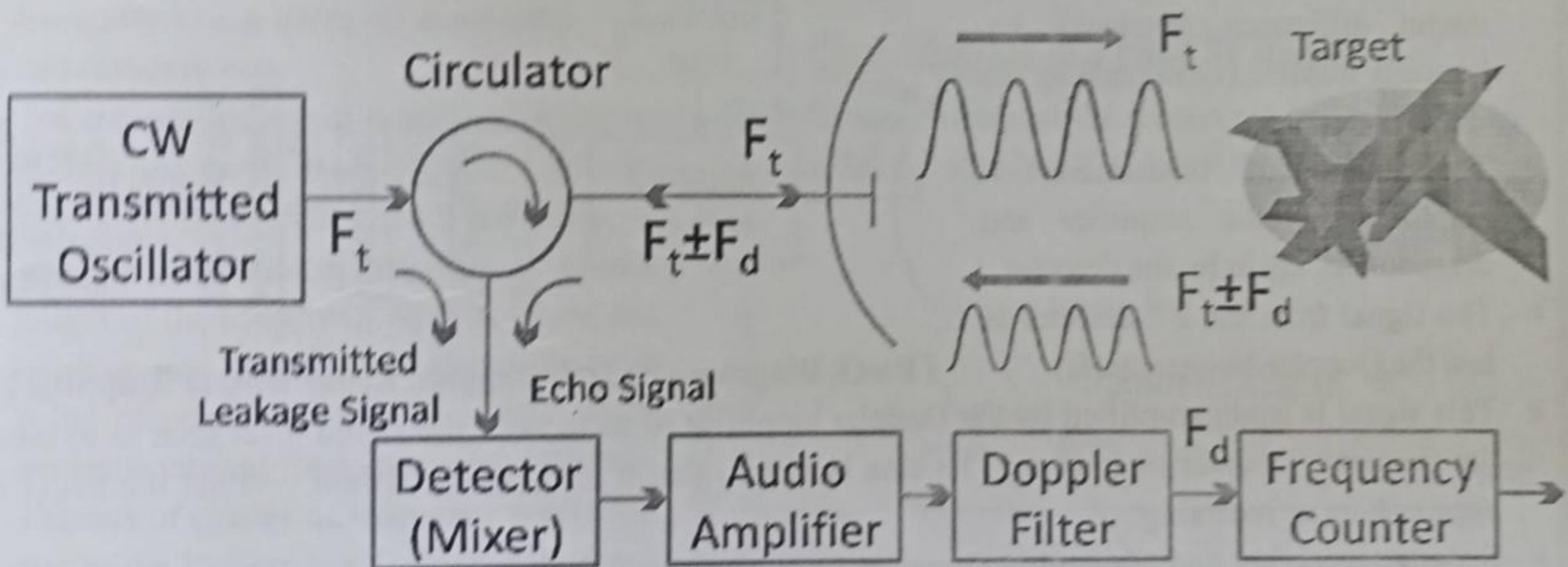

[ BLOCK DIAGRAM OF A CW DOPPLER RADAR ]

- The CW Transmitter generates a continuous sine wave rather than pulse (Unmodulated) of frequency  $f_t$  which is radiated by the antenna. Since, here the transmission is continuous the Circulator is used to provide isolation between transmitter & receiver. For continuous wave the use of duplexer is pointless.
- A Portion of radiated energy is intercepted by the target and scattered. Some of it in the direction of Radar where it is collected by receiving antenna.
- If the target is in motion with a velocity of  $V_R$  relative to the Radar, the received signal will be shifted in frequency from the transmitted frequency  $f_t$  by an amount of  $\pm f_d$ .
- The plus (+) sign associated with the Doppler frequency applied, if the distance between the target and the Radar is decreasing (when they moving towards each other) i.e. when the received signal frequency is greater than the transmitted signal frequency. The minus (-) sign applied if the distance is increasing i.e. target is away going from the Radar.
- Hence the received echo signal at the frequency  $f_t \pm f_d$  enters to the Radar via antenna.

### ➤ Moving Target Indicator Radar (MTI):-

- This Radar uses Doppler Effect for its operation many times it is not possible to distinguish a moving target in the presence of static or permanent echoes of comparable appearance on the Radar screen.
- We have seen that in a PPI display, there is a lot of clutter due to this stationary target echoes. When it is desired to remove the clutter due to the stationary target an MTI Radar is employed.
- The basic principle of MTI Radar is to compare a set of received echo with those received during the previous. Sweep and Cancelling out those whose phase has remain unchanged.
- Moving target will give change of phase and are not cancelled thus clutter due to the stationary target are remove from display and this allows easier detection of moving target.
- The side block diagram is the simple block diagram of simple MTI Radar.
- The Transmitter frequency in the MTI Radar System is the sum of the o/p of two oscillators produced in mixer 2.

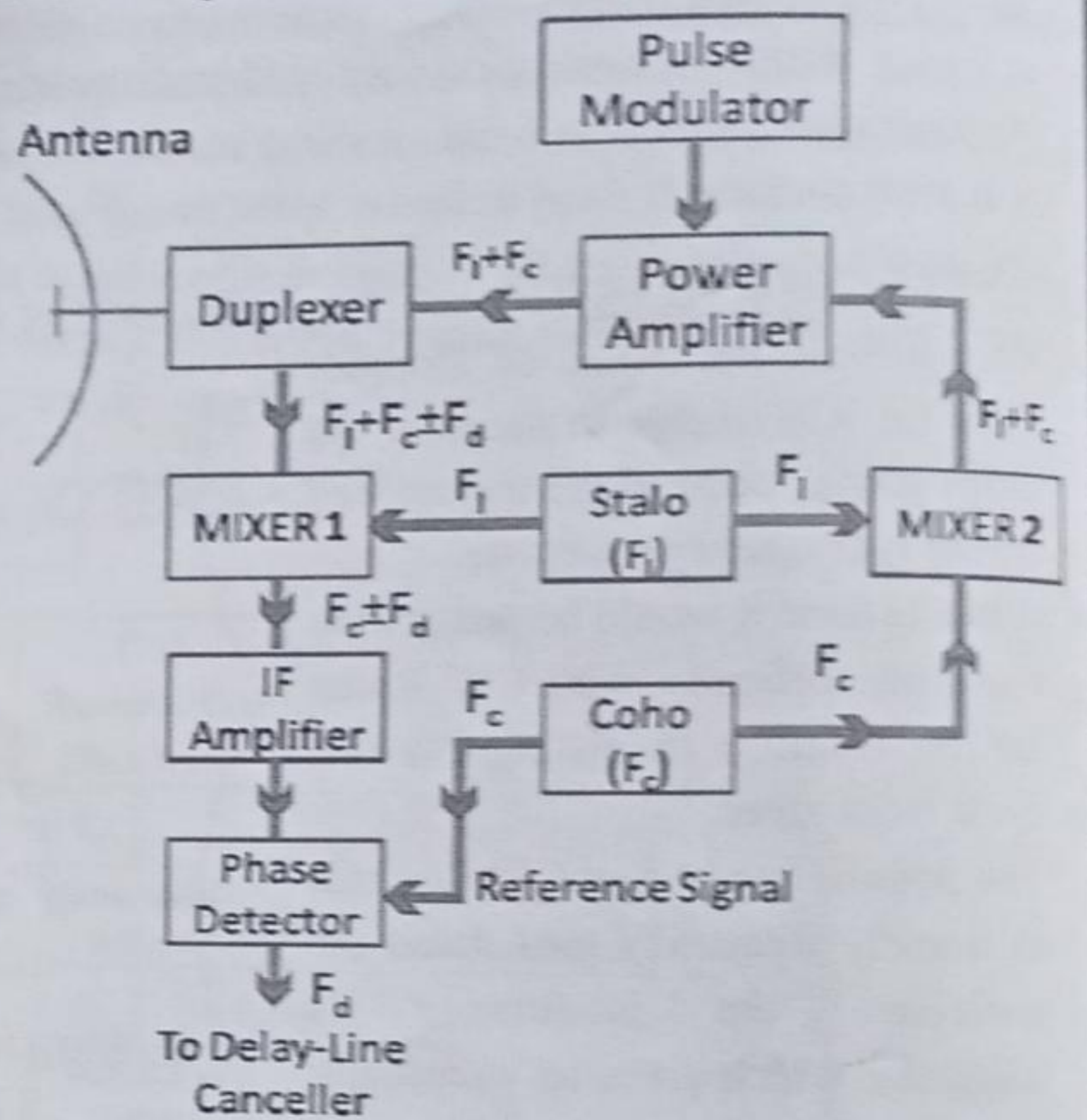

[ BLOCK DIAGRAM OF A MTI RADAR SYSTEM ]

- The First oscillator is the Stalo (Stable Oscillator) and the Second one is Coho (Coherent Oscillator) which operating same frequency as the intermediate frequency & providing coherent signal.
- The Coho is used for generating the R.F. signal as well as reference signal for the phase detector.
- The output of the duplexer is the combination of transmitted frequency and Doppler shift frequency.
- At the mixer-1 the Stalo frequency ( $f_1$ ) cancels out and feeds a signal of frequency  $f_c \pm f_d$  to I.F amplifier for amplification.
- The reference signal from the Coho and the I.F echo signal are both feed into the mixer called phase detector. The phase detector differs from the normal amplitude detector, since its output is proportional to the phase difference between the two input signals.
- Since the output of this detector is phase sensitive and output will obtain for all fixed or moving target.
- The phase difference between transmitter & receiver signal will be constant for a fixed target where as it will vary for a moving target. This variation of moving target is due to the Doppler frequency shift.
- The delay line canceller not only eliminate the DC component caused by clutter but also it unfortunately rejects the any moving target whose Doppler frequency happens to be same as the PRF (Pulse Repetition Frequency) or multiple of PRF. ( $f_d = n f_p$ )
- Those related target velocities which result is zero MTI response are called blind speed and is given by

$$V_n = n\lambda/2T = n\lambda f_p/2 \quad \text{Where } n = 1, 2, 3, \dots$$

☉ An MTI RADAR operates at frequency 5GHz with a PRF of 800pps. Calculate the lowest three blind speeds of this RADAR.

▪ Given that :  $f = 5\text{GHz} = 5 \times 10^9 \text{Hz}$ ,  $\text{PRF} = 800\text{pps}$   
 As  $\lambda = c/f = (3 \times 10^8) / (5 \times 10^9) = 3/50 = 0.06\text{m}$   
 $V_{n1} = n\lambda f_p/2 = (1 \times 0.06 \times 800)/2 = 24\text{m/s}$ ,  $V_{n2} = (2 \times 0.06 \times 800)/2 = 48\text{m/s}$  &  $V_{n3} = (3 \times 0.06 \times 800)/2 = 72\text{m/s}$

## GPS (Global Positioning System) :-

- GPS stands for global positioning system which is started in 14<sup>th</sup> Feb. 1989.
- A GPS system has three segments.
  - Space Segment
  - Control Segment
  - User Segment

### ❖ Space segment:-

- In space segment system it contains 24 operational satellite which are revolving around the earth in 6<sup>th</sup> different orbit there are used an spare and there are arranged in such a manner at least four satellite are in view to an user at any time on a worldwide base.
- Out of four satellites three are for dimension one for time.
- GPS Satellite Transmits Pseudo Random Noise (PRN) frequency with cars acquisition and precision code. This can be achieved by CDMA process to identify transmit a particular providing a unique PRN number.

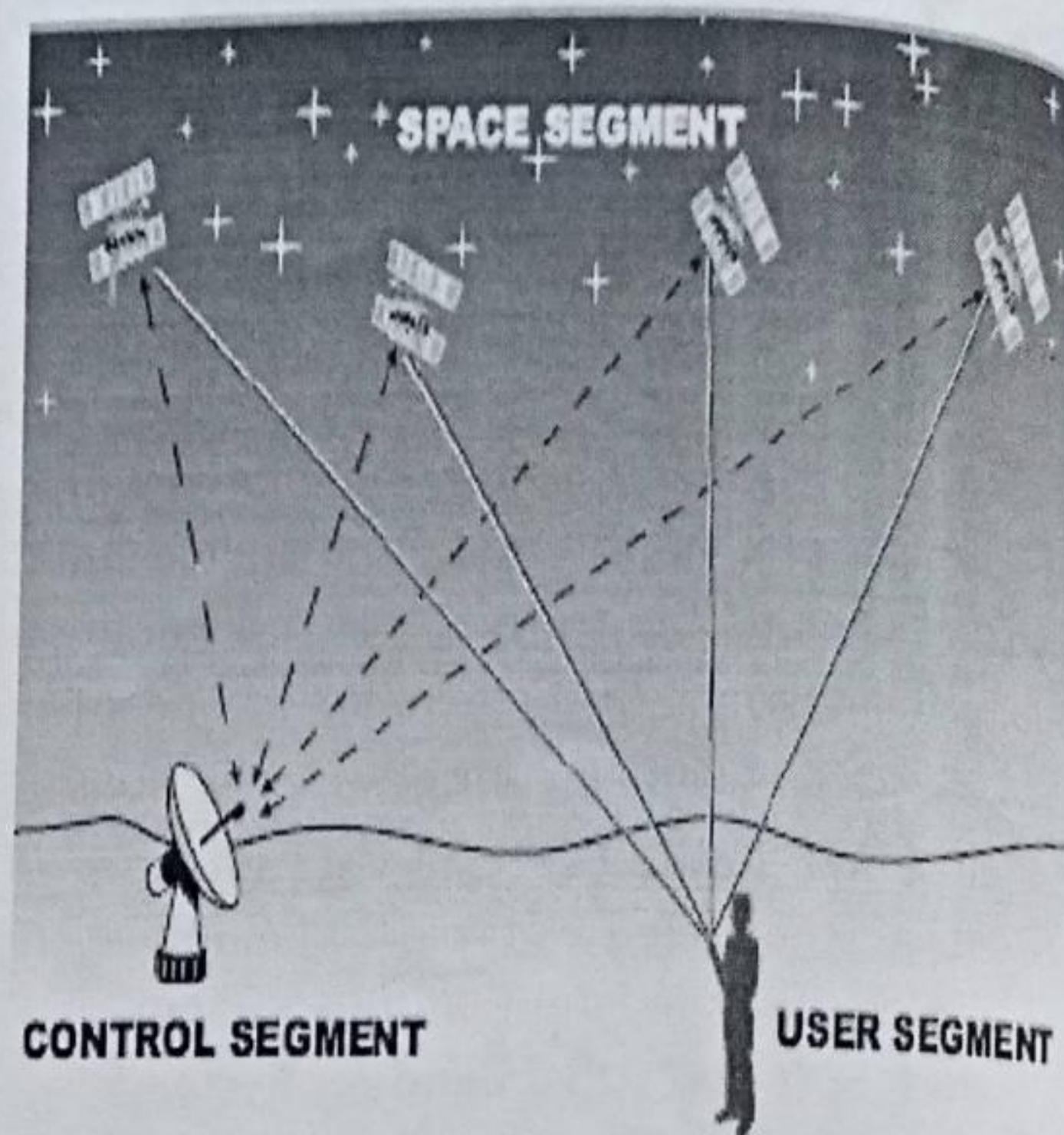

### ❖ Control segment:-

- It includes a master control station & number of monitory & general antenna allocated throughout the world. They are all interlinked & all the information received is processed by master control system.
- After calculation of accuracy master control system it is transmitted to the antenna by which a position can identify through satellite.

### ❖ User Segment:-

- User segment contain high, medium and low receiver the user equipment is so designed so that it receives the signal and process all at a time or sequentially then the processor converted signal into 3-dimensaonal navigational information.

## ☉ FOUR STEPS FIND THE POSITION:

- Measuring travel time of satellite signal.
- Measurement of distance from satellite.
- Measurement of position of satellite.
- Trilateration.

## ☉ LIMITATION OF GPS

- Line-Of-Sight Essential – Signal cannot pass through building, it happens in urban area, i.e. Sydney city circle.
- Long position time – Around 15 minutes, depends on how accuracy.
- Battery - Run out of the battery in GPS receiver, since long calculation time, 4 AA batteries can last for 4 hours only.
- Need improvement? Cellular Network!

...ॐ...ALL...ॐ...THE...ॐ...BEST...ॐ...ALL...ॐ...THE...ॐ...BEST...ॐ...



## [CHAPTER-III]

## FIBER OPTICS COMMUNICATION SYSTEM

- Fiber optics is a branch of science which deals with the study of propagation of light through transparent dielectric medium such as optical fibers.
- Fiber optics is a relative new technology that used to transmit television, voice and digital data signal by light waves over flexible hair like threads of glass and plastic.
- Optical fiber is the medium in which the communication signals are transmitted from one location to another in the form of guided light.
- This signal can be voice information, data information, video information and any other information.
- The process of communicating using fiber optics involves the following basic steps.
  - I. Creating the optical signal along the fiber.
  - II. Relaying the signal along the fiber.
  - III. Ensuring that the signal does not become to distort or weak.
  - IV. Receiving the optical signal.
  - V. Converting it in to electrical signal.

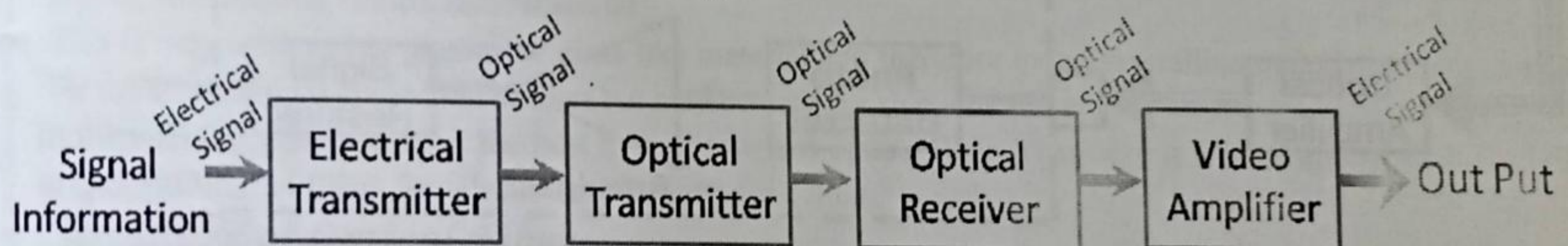

[ Simple Block Diagram of a FOCS ]

### ❏ ADVANTAGE

- *Attenuation* in a fiber is lower than that of coaxial cable or twisted pair and is constant over a very wide range. So transmission within wide range distance is possible without use of repeaters.
- *Smaller size and lighter weight*. So that it occupy much less space.
- Due to *Electromagnetic Isolation* the system is not vulnerable (risk) to interference, impulse noise or cross-talk.
- Fiber optical cable has much *greater band width* than copper wire.
- Fiber optic cable is *less susceptible* to signal degradation than copper wire.
- Data can be transmitted *digitally* and Data rate is much higher. As for example the data rate is 2 Gbps over some kilometers in case of fiber optics where as for coaxial/twisted cable it is about 1 Mbps over one kilometer.
- *Lower power transmitter* can be used instead of the high voltage electrical transmitter used for the copper wire.
- Because of no electricity is passed through optical fiber it is *nonflammable and immune* to light.
- No cross-talk in optical fibers and hence transmission is *more secure* and private as it difficult to tap into fiber.

### ❏ DISADVANTAGE

- Fiber optics is the cables which are expensive to installation.
- The termination of fiber cable is complex and requires special tools.
- They are more fragile (easily broken) than co-axial cable.

### ❏ APPLICATIONS

- Used in Voice Communications. (Inter-Office, Intercity, Intercontinental links etc)
- Video Communications. ( TV Broadcast, Cable Television, Remote Monitoring, Wired City, Videophones etc)
- Data Transfer (Inter Office Data Link, Local Area Network, Satellite Ground Stations, Computers etc)
- Internet (Email, Access to remote information, Video Conferencing etc)
- Sensor System ( Point Sensor, Distributed Sensor, Smart Structure, Robotics etc)
- Also it used in other indirect fields like Entertainment (HDTV), Power System, Transportations, Health Care

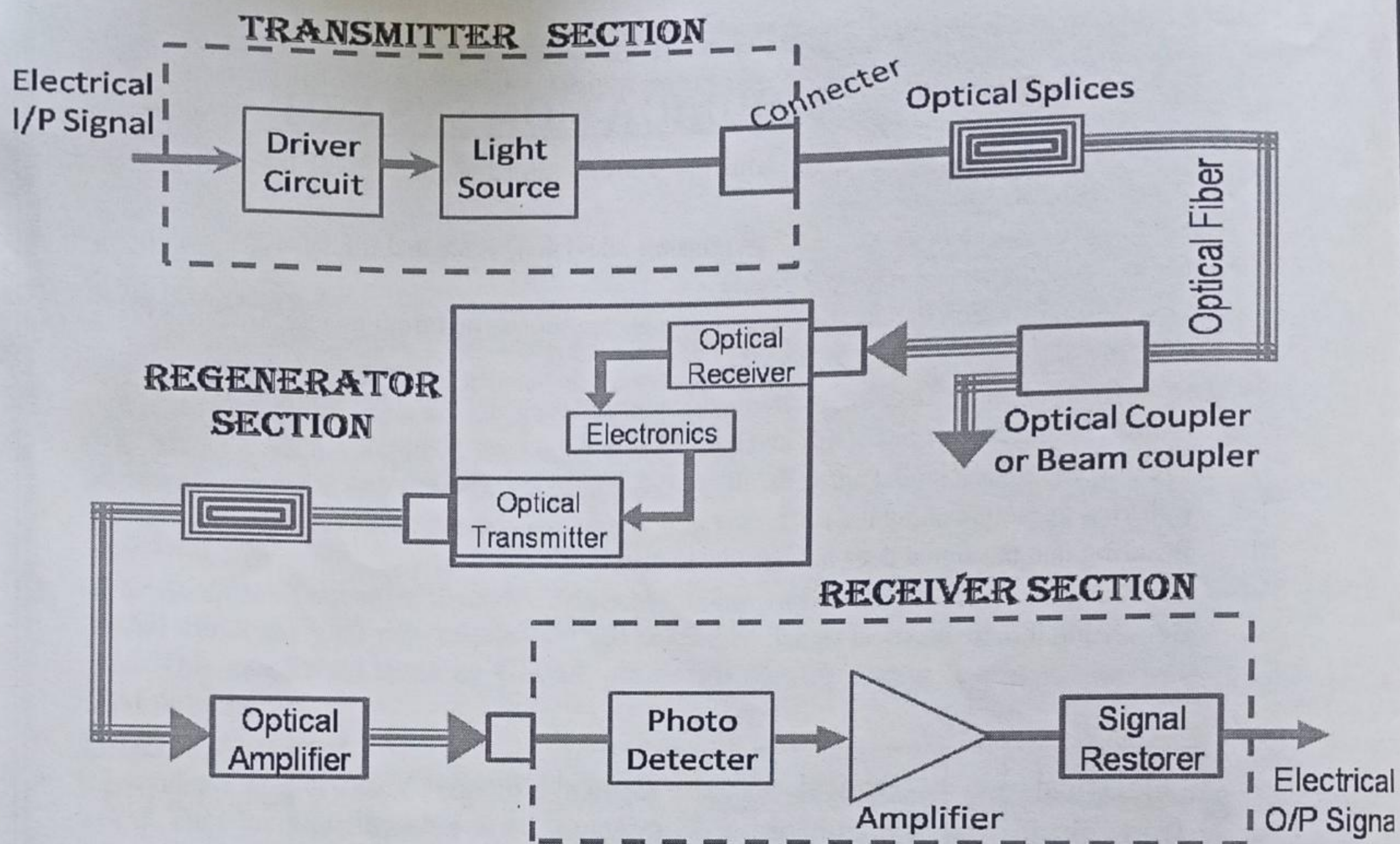

[ Block Diagram of a Fiber Optics Comm. System ]

- The block diagram of FOCS contains following components. Light Signal, Transmitter, Optical Fiber, Photo Detecting Receiver, Cable Splices, Connector, Regenerators, Beam Splitters and Optical Amplifier etc.
- Modern fiber optics communication system general includes an optical transmitter to convert an electrical signal to an optical signal to send into the optical fiber.
- In this section the electrical signal is converted into optical signal with the help of light source and associated circuit. We use light sources like semiconductor LED or LASER diodes since their light output can be modulated rapidly by simply varying the bias current at the desired transmission rate.
- Optical fiber cables are the medium for the transmission of signal. It carries the data, audio or video information in the form of optical signal. The cable containing bundles of multiple optical fiber that is routed through underground and buildings.
- An optical receiver is used to recover the signal as an electrical signal. The information transmitted in typically digital information generated by Computer, Telephone System or Television Company.
- In the receiver section a photo diode is there which treated the weakened optical signal and convert it to electrical current referred to as photo current. This photo current in the form of electrical signal is amplified by the amplifier.
- The signal restored will produce the required form of the signal at the output. Cable splices are used to joint between the two fiber optical cables.
- Connectors are connected just the end of the transmitter and receiver to connect with fiber optics cable. Its construction is more complex than that of splices. Beam splitter or optical couplers are used to split the optical signal into different parts for different communication system.
- Different type of optical amplifier is there to amplify the optical signal. Regenerators are used for restoring the signal shape characteristic.
- In a long distance transmission the degradation of optical signal takes place so to restore the signal shape characteristic over a long distance regenerators are used. This is mainly used under sea where the longest cables are employed.

❖ Optical Fiber Cable Characteristics:

- Optical fiber may be produced with good stable transmission characteristics in long lengths at a minimum cost and with maximum repeatability.
- The range of optical fiber size with suitable to size, refractive index, operating wave length, material etc is available in order to fulfill many different system applications.
- The fiber may be converted into practical cable which can be handled in a similar manner to a electrical transmission cable without any problem.
- For transmission point of view it is clear that a variation of refractive index inside the optical fiber (core and cladding) is the fundamental necessity in the fabrication of fiber for light transmission.
- Hence at least two different materials which are transparent to light over the current operating wave length range are required.
- In practice these material must exhibit relatively low practical attenuation and they must therefore have low intrinsic absorption and scattering losses.
- A number of organic and inorganic insulating substances are used to meet these conditions. We choose suitable material for the fabrication of optical fibers to either glasses or glass like material & mono crystalline structure.
- It is well felt in the case of graded index fiber that the refractive index of the material may be varied by suitable doping with another compatible material.
- This is only achieved in glasses or glass like material and therefore mono crystalline material are not suitable for the fabrication of graded index fiber but may be used for step index fiber.
- It is clear that glasses exhibit the best overall low loss optical fiber. Therefore it is used almost exclusively in the preparation of fibers for telecommunication application.

❖ Structure of Optical Fiber:

- The working of optical fiber is based on the principle of total internal reflection of light.
- The possible of light being guided through narrow jet of a communication system based on the propagation of light with in a cylindrical wave guided called optical fiber.
- The light entering at one end of the fiber has to travel through the entire length and emerge at the other end without much loss.

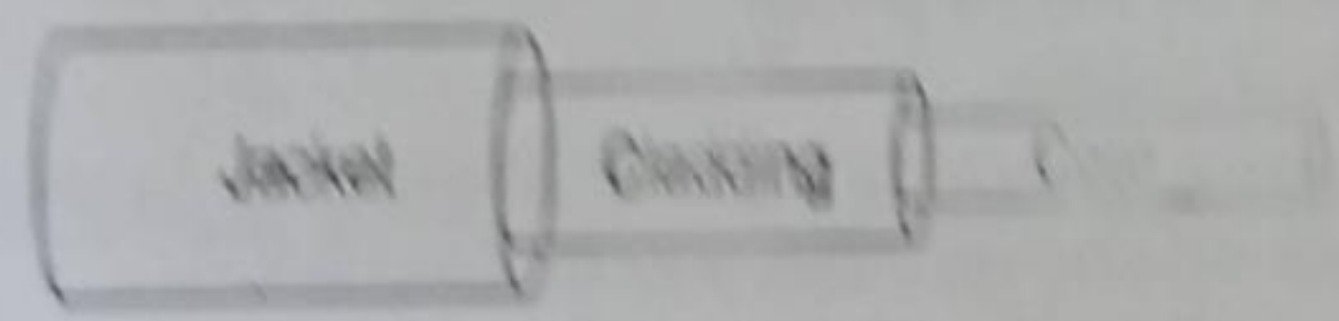

[Structure of Optical Fiber]

➤ Optical fiber consists of three section such as

- I. CORE
- II. CLADDING
- III. JACKET

- The CORE of an optical fiber is a thin cylindrical fiber of glass or transparent dielectric material like plastic. The Core is coated with a layer of material with lower refractive index this layer is called CLADDING.
- The core and cladding together guide optical energy along the axis of fiber.
- The core diameter generally 5-100 micron while the cladding diameter is around 125 micron.
- For greater strength and protection of fiber a soft plastic coating or outer cover which is primary which diameter is around 250 micron is used called JACKET or PRIMARY JACKET.
- This is often followed by another layer of hard protective material which is called SECONDARY JACKET. The entire unit is remaining flexible for use.

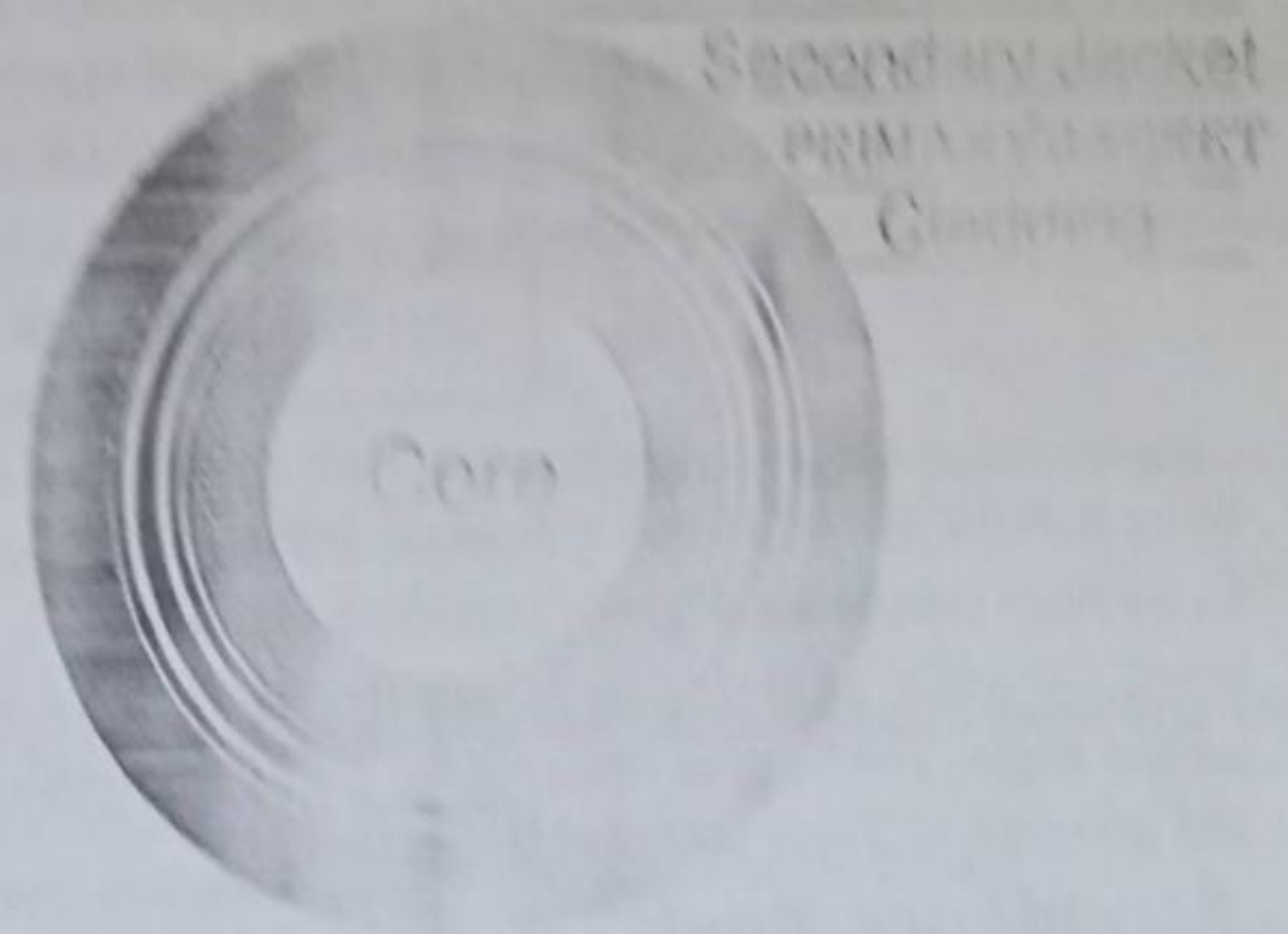

[Cross-Sectional View of Optical Fiber]

❖ Propagation of Light in Optical Fiber:-

- In free space the light wave travels at speed  $C=3 \times 10^8 \text{ N/s}$  upon entering to a dielectric and non conductive medium the wave now travels at a speed 'V' and is less than that of 'C'.
- The ratio of speed of light in vacuum to that of in a metal is known as **Refractive Index** of the material and given by

$$\frac{C}{V}$$

Typical values of Refractive Index is given by  
 $n=1$  for Air,  $n=1.33$  for Water,  $n=1.50$  for Glass,  $n=2.42$  for Diamond etc.

- When a light ray encounters a boundary separating two different media, part of the ray has reflected back into the 1<sup>st</sup> medium. Then the remainder is bending or refracted as it enters to the second material.
- The bending or refraction of light ray at the interface as a result of difference in the speed of light in two materials that have different refractive indices.
- The relationship at the interface is known as **Snell's Law** and is given by

$$n_1 \sin \Phi_1 = n_2 \sin \Phi_2$$

$$\rightarrow n_1 \sin (90 - \theta_1) = n_2 \sin (90 - \theta_2)$$

$$\rightarrow n_1 \cos \theta_1 = n_2 \cos \theta_2$$

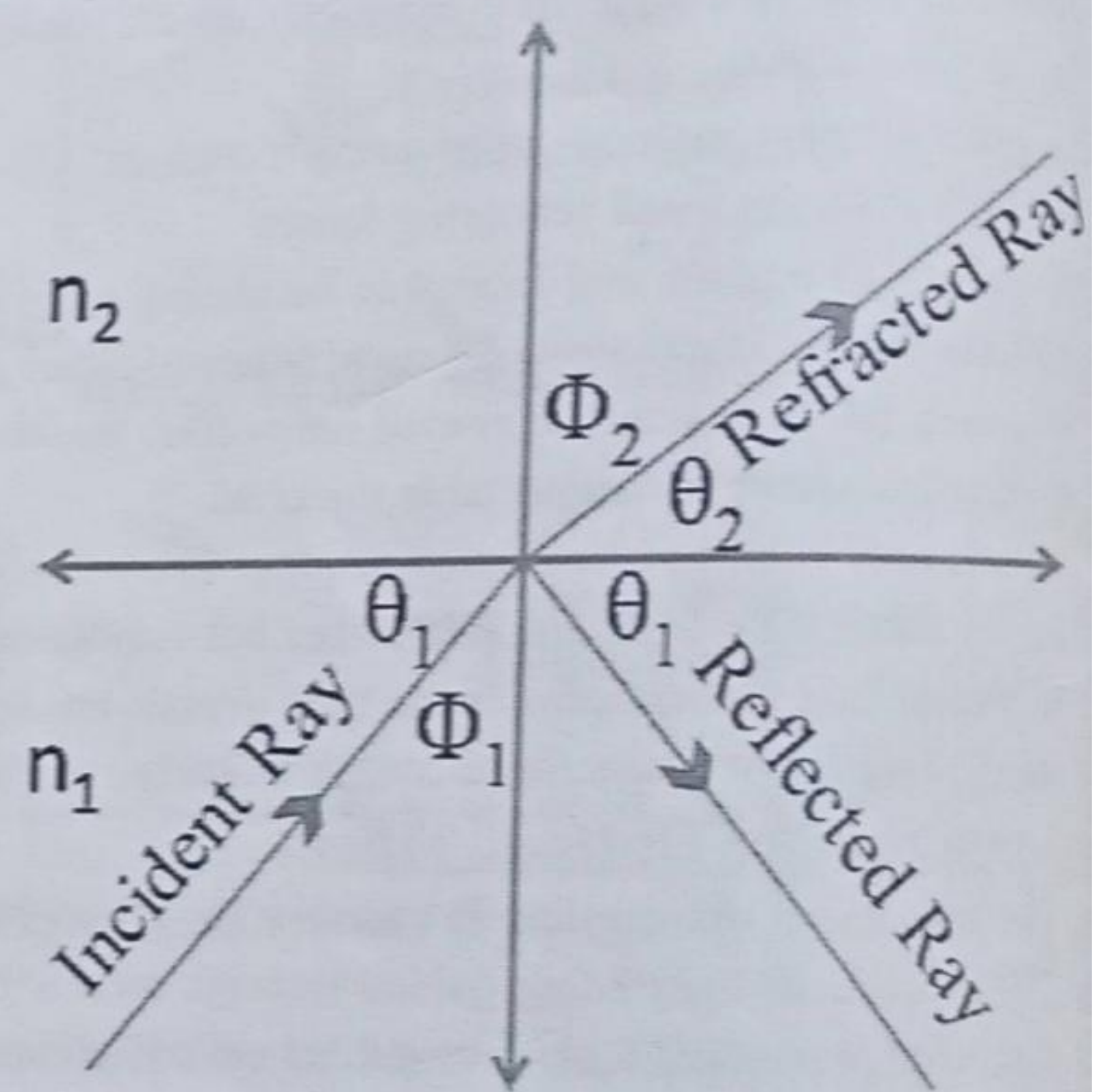

[Light Propagation in Optical Fiber]

- The angle  $\phi_1$  between the incident ray and the normal to the surface is known as Angle of Incident.
- According to the Laws of Refraction the incident angle "θ" at which the incident ray strikes to the interface is exactly equal to the angle that the reflected ray makes with the same interface.
- In addition the incident rays the normal to the interface and the reflected ray all lies on the same plane.
- As  $n_1$  is greater than  $n_2$  the angle of refraction is always greater than that of angle of incident.
- If the angle of incident  $\phi$  is increased a point will eventually reached where the light ray in air is parallel to the glass surface. This point is known as **Critical Angle ( $\phi_c$ )** of the incident.
- The value of critical is given by

$$\sin \theta_c = n_2 / n_1 \rightarrow \theta_c = \sin^{-1} (n_2 / n_1)$$

- When  $\theta_c = 90^\circ$  then  $\sin 90^\circ = n_2/n_1 = 1 \rightarrow n_2 = n_1$ .
- So we must choose the angle of incidence less than  $90^\circ$ .
- When the angle of incidence is greater than that of the critical angle. The light is reflected back into the medium and is known as **Total Internal Reflection**.

❖ Acceptance Angle:-

- Any ray which are incidence into the fiber core at an angle greater than  $\theta_a$  will be transmitted to the core cladding interface at an angle less than ' $\phi_c$ ' will not be total internal reflection.

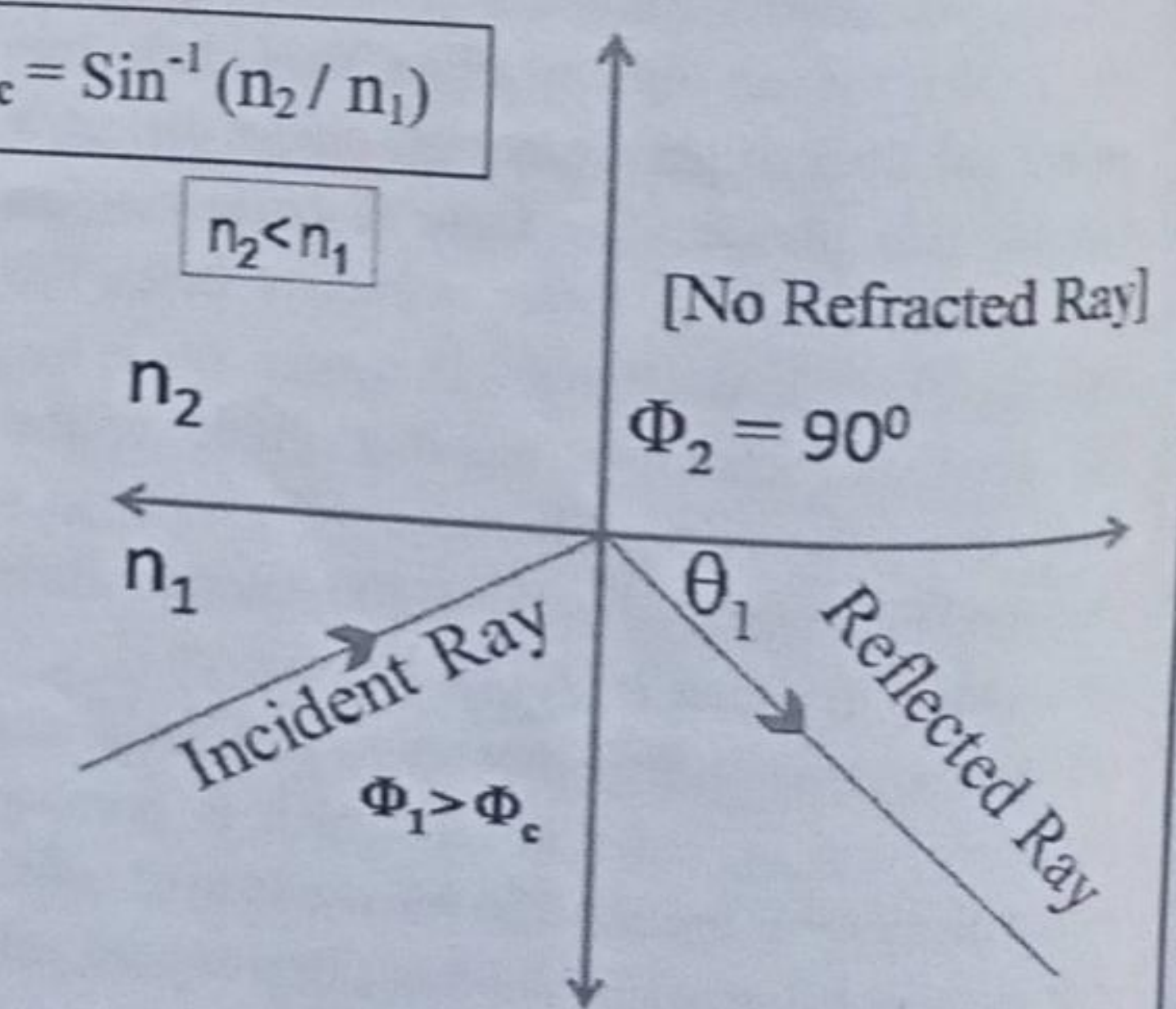

[Total Internal Reflection of Light; When  $\Phi_1 > \Phi_c$ ]

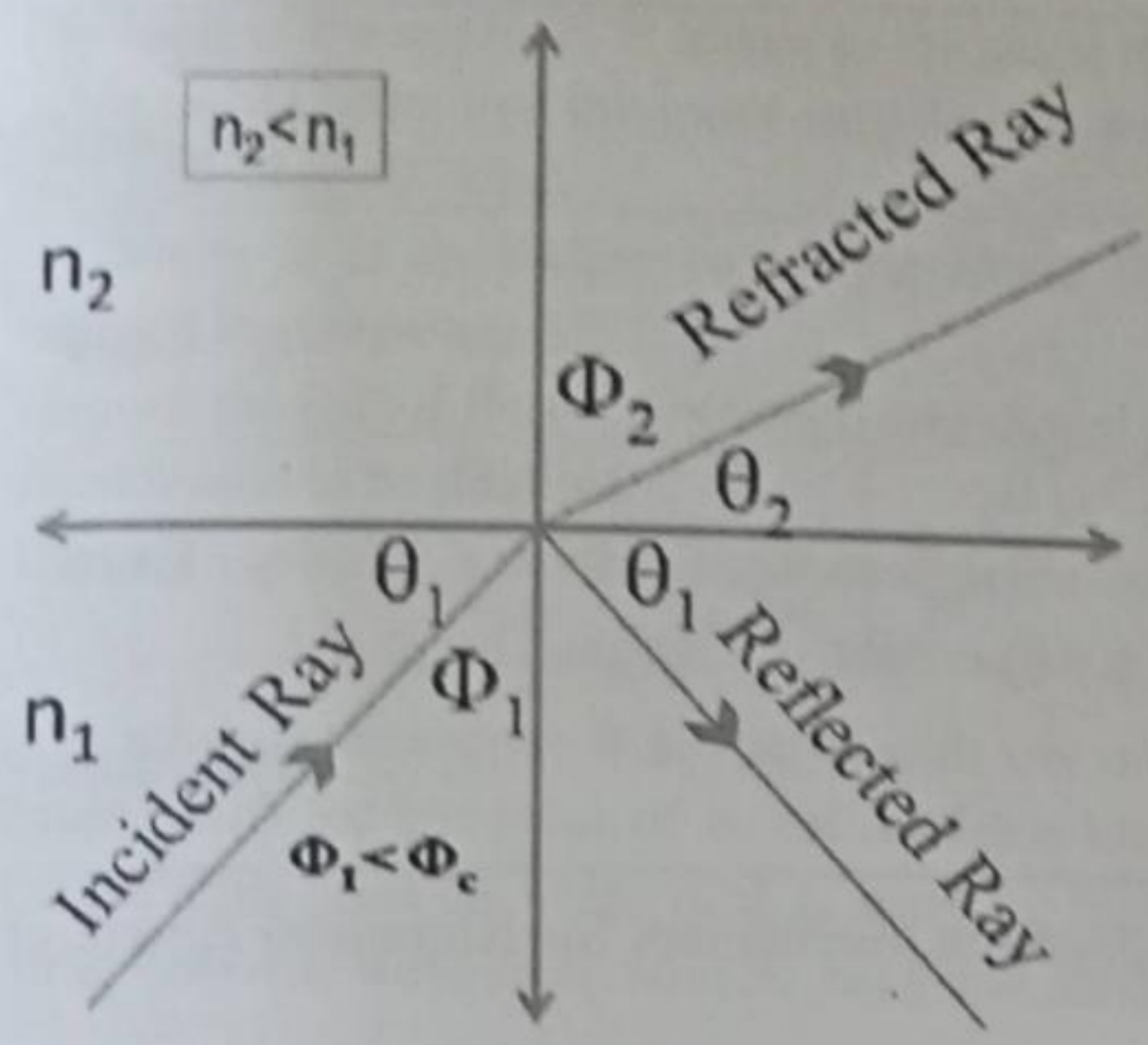

[ Light Propagation in Optical Fiber when  $\Phi_1 < \Phi_c$  ]

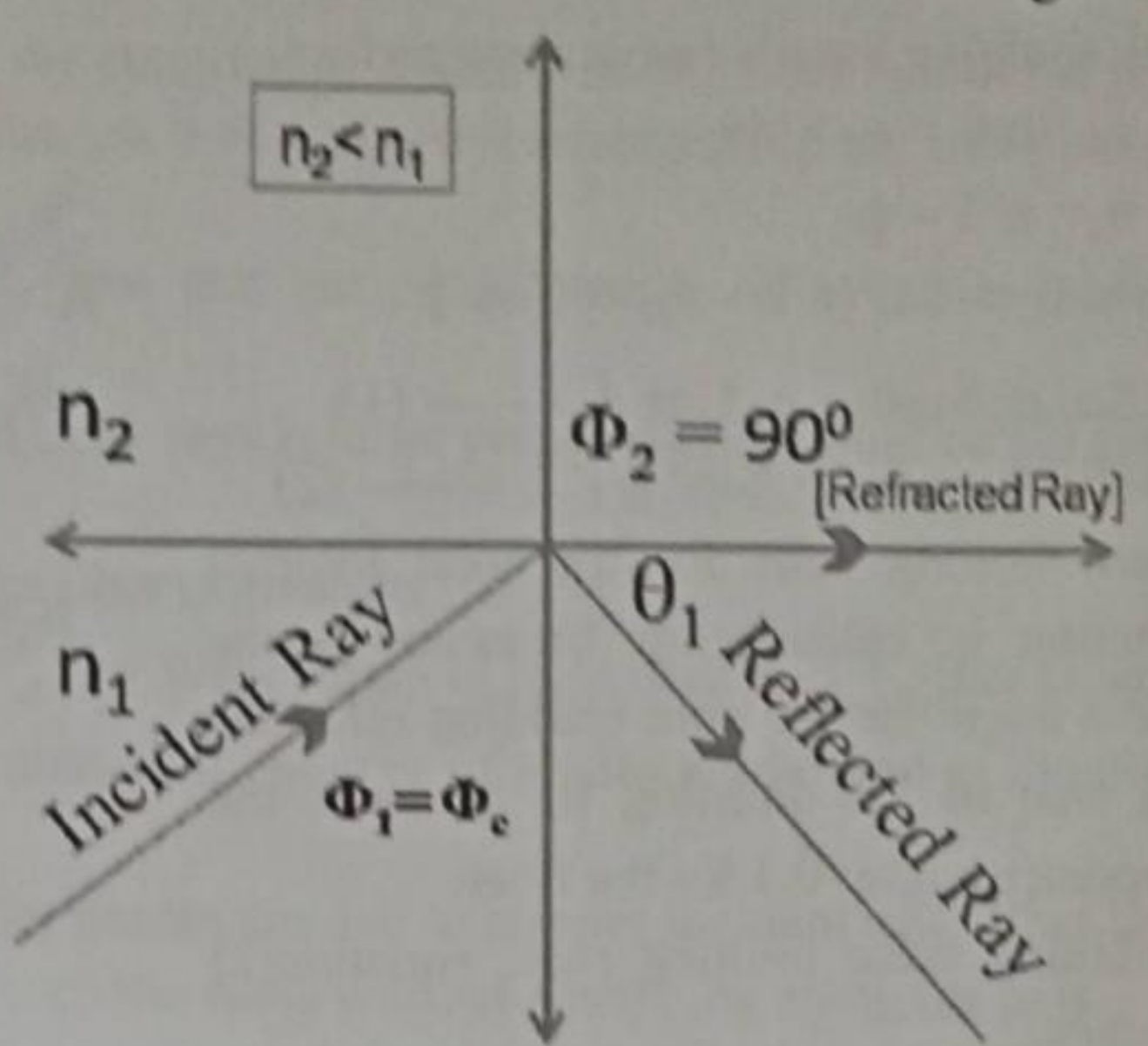

[ Light Propagation in Optical Fiber when  $\Phi_1 = \Phi_c$  ]

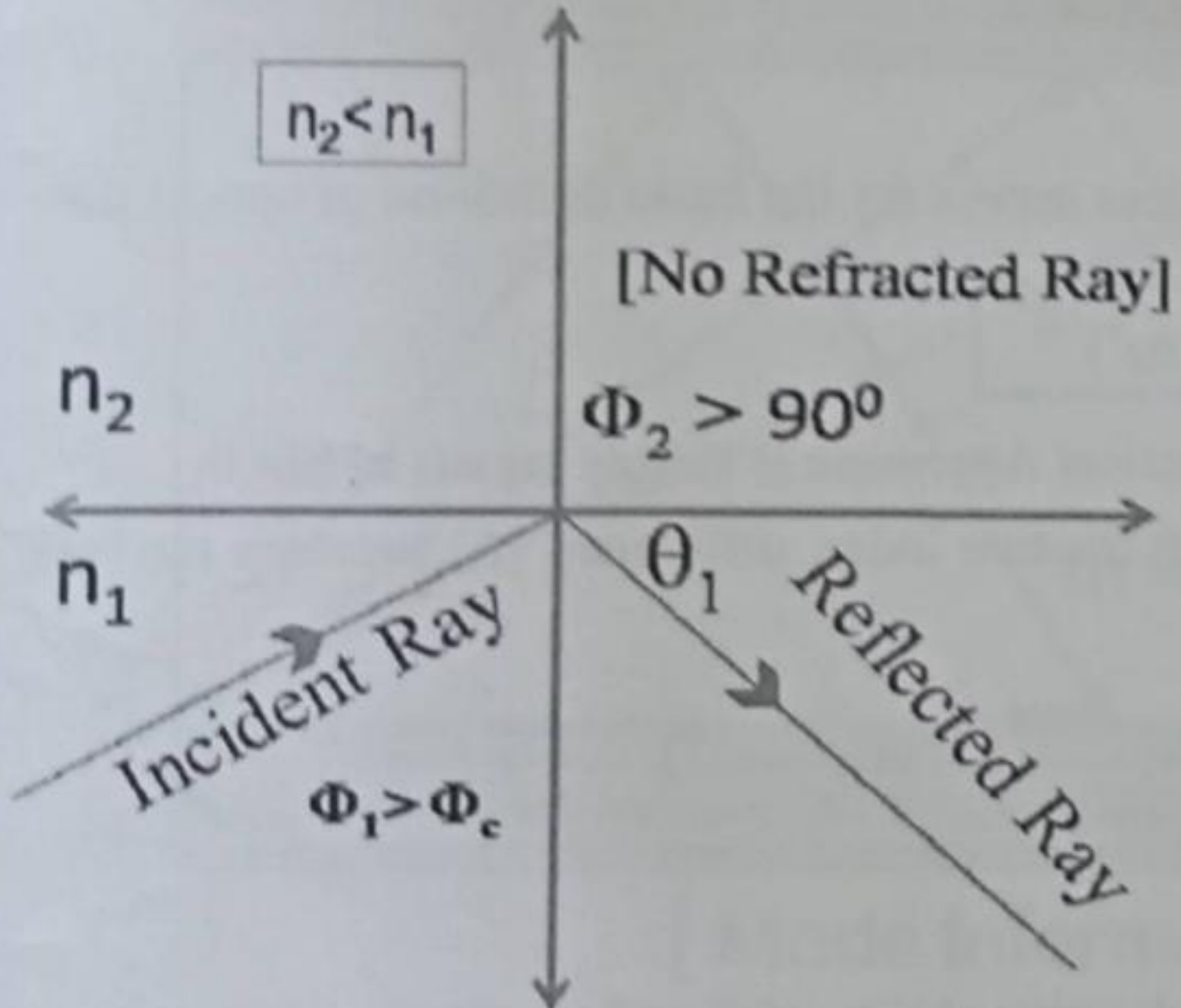

[ Light Propagation in Optical Fiber when  $\Phi_1 > \Phi_c$  ]

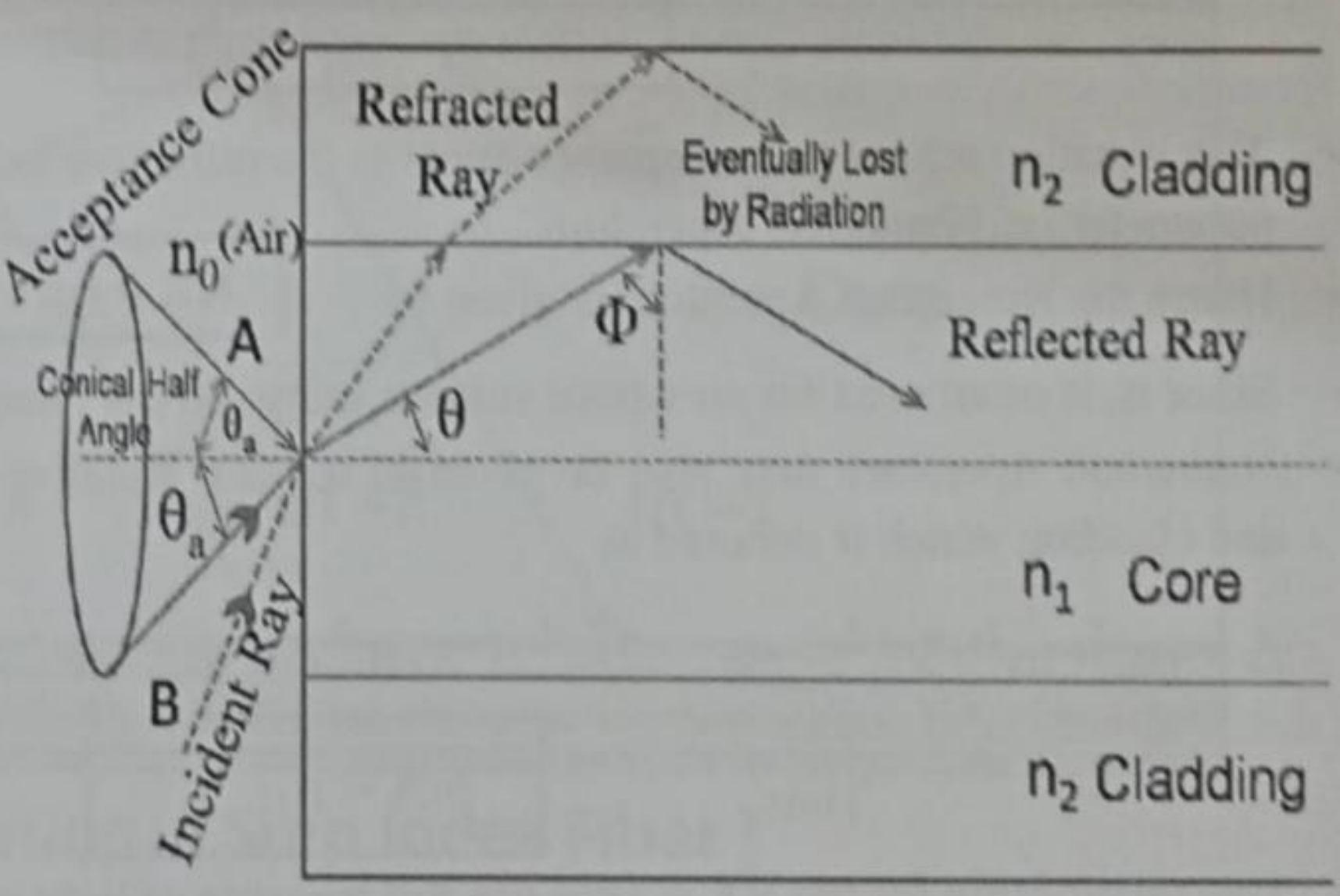

[ Propagation Mechanism for in an Ideal Step-Index Fiber ]

- From the above figure the incident ray 'B' at an angle greater than  $\theta_a$  is refracted into the cladding and is eventually loosed by the radiation.
- Thus for rays to be transmitted by total internal reflection within the fiber core, they must be incident on the fiber core with in an acceptance angle and is also defined by **Conical Half Angle** ( $\theta_a$ ).
- Hence  $\theta_a$  is the maximum angle to the axis at which light may enter to the fiber in order to propagate fully and is refer as acceptance angle for the fiber.
- $\theta$  is some time refer as maximum or total acceptance angle .
- It may be noted that the output angle to the axis will be equal to the input angle for the ray assuming the ray emerges in to a medium o the same refractive index from which it was input.

❖ **NUMERICAL APERTURE:-**

- It is possible to continue the ray theory analysis to obtain a relation between the acceptance angle and the refractive indices of the three medium involve such as core, cladding and air.
- This leads to the definition of a more generally used term that the Numerical Aperture of the fiber.
- The figure of the next page shows a light ray incident on the fiber core at an angle  $\theta_1$  to the fiber axis which is less than the acceptance angle for the fiber  $\theta_a$ .
- The ray enters to the fiber from a medium (Air) that the refractive index ' $n_0$ ' and the fiber refractive index ' $n_1$ ' which is slightly greater than the cladding refractive index ' $n_2$ '.

➤ Now applying Snell's law at the interface

$$n_0 \sin \theta_1 = n_1 \sin \theta_2$$

But  $\theta_2 = \pi/2 - \phi$

$$\rightarrow \sin \theta_2 = \sin (\pi/2 - \phi) = \cos \phi$$

$$\text{So, } n_0 \sin \theta_1 = n_1 \cos \phi \text{ ----- (1)}$$

$$\rightarrow n_0 \sin \theta_1 = n_1 (1 - \sin^2 \phi)^{1/2} \text{ ----- (2)}$$

➤ When limiting case for the total internal reflection is consider  $\phi$  becomes to the critical angle for the core cladding interface ( $\phi_c$ ) also in this limiting  $\theta_1$  becomes the acceptance angle ( $\theta_c$ ) for the fiber.

➤ Combining these limiting case, equation(2) becomes,

$$n_0 \sin \theta_a = n_1 (1 - \sin^2 \phi_c)^{1/2} \rightarrow n_0 \sin \theta_a = n_1 [1 - (n_2/n_1)^2]^{1/2} \quad \{ \text{As } \sin \phi_c = n_2/n_1 \}$$

$$\boxed{n_0 \sin \theta_a = (n_1^2 - n_2^2)^{1/2}}$$

➤ This equation relates the acceptance angle to the refractive indices serves for the basic definition of optical fiber parameter i.e. Numerical Aperature.

➤ Hence the Numerical Aperature is given by

$$\boxed{NA = (n_1^2 - n_2^2)^{1/2}}$$

➤ Since  $n_0$  is often used for air whose value is unity. So the Numerical Aperature is simply equals to  $\sin \theta_a$ .

➤ Numerical Aperature may also be given in terms o Relative refractive index difference ( $\Delta$ ) between the core and cladding which is denoted as

$$\Delta = (n_1^2 - n_2^2)/2n_1^2 \rightarrow 2n_1^2 \Delta = (n_1^2 - n_2^2) \rightarrow n_1 \text{ ---} = (n_1^2 - n_2^2)^{1/2}$$

Thus,

$$\boxed{NA = n_1 \text{ ---}}$$

➤ This relationship for the NA is very use full measure of light collective ability of the fiber.

❖ **MODES OF PROPAGATION:-**

➤ Propagation of light along an optical fiber can be described in terms of a set of guided electromagnetic waves called the MODES.

➤ Each guided mode corresponds to a patterns of electric and magnetic field distribution that is repeated along the fiber at regular intervals. Only a certain discrete number of modes or patterns are capable of propagating along the fiber.

➤ For monochromic light the amplitude of a mode traveling along the fiber axis (say the +ve z-direction) is represented as

$$\Psi (z,t) = Ae^{j(\omega t - \beta z)} \text{ , Where } \omega = 2\pi\nu \text{ and } \beta \text{ is the z-component of propagation vector } k = 2\pi/\lambda \text{ in z-direction.}$$

➤ For guided modes,  $\beta$  can have only certain discrete values that satisfies the maxwell's equation and the boundary conditions. These modes are identified by solving maxwell's EM wave equation under the boundary condition of the wave guide surface.

➤ The modes can also be visualized by ray tracing method.

➤ A guided mode travelling along the fiber can be regarded to be assembly of a group of plane waves along the axis with a common wave front.

➤ Since with any plane wave can associate a light ray that is normal to the wave front of the wave, group of waves corresponding to a particular mode from a set of ray called a Ray Congruence.

➤ Each ray of this particular group is incident at the core cladding interface at the same angle. Note that any ray that satisfies the condition ( $\theta \geq \theta_c$ ) can be transmitted in the fiber yet the constant phase condition is satisfied only in limited cases. i.e. there will be limited number of ray congruence or modes.

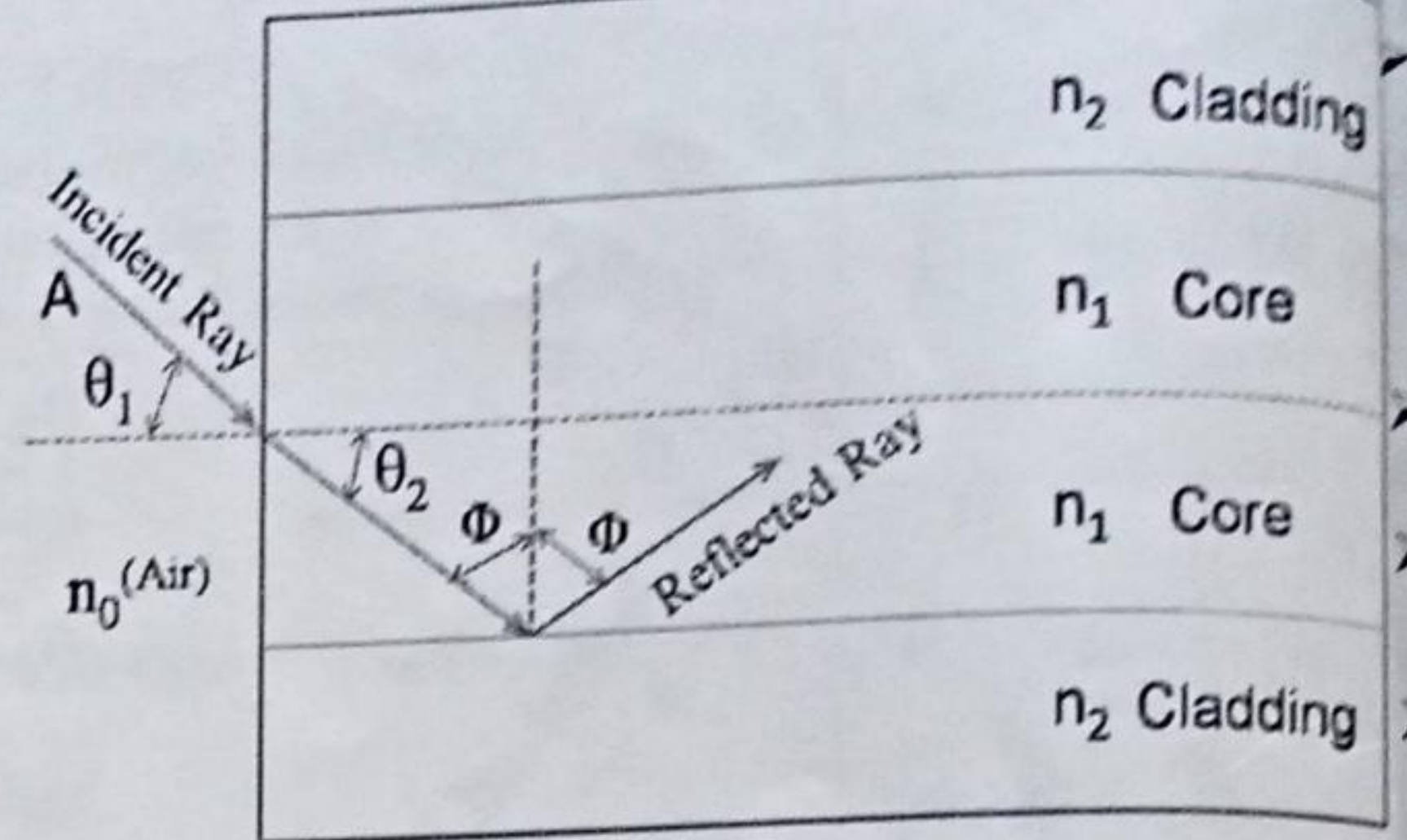

[Propagation Mechanism for Numerical Aperature]

- The order of the mode  $m$ , is linked to the angle that the ray congruence makes with the fiber axis at the point of incidence. In order that the mode rays satisfy the condition,  $\theta > \theta_c$  and also converge in the same phase, the path difference  $\Delta P = m\lambda$ .

Where  $m$  is an integer called the Mode Number. Note that the phase change on reflection should be included in computing  $\Delta P$ .

- Through the path difference between meridional ray and skew rays is large yet the phase should be the same for transmission to be possible.
- The angle  $\phi$  which a mode ray makes with the wall of the fiber is given by
 
$$\sin \phi = \left(\frac{m}{2}\right) \lambda/d < 1, \text{ where } (\theta + \phi) = 90^\circ, \lambda = \text{Wavelength of light used \& } d = \text{Fiber Diameter.}$$
- Through a distinct mode is available with any integer value of  $m$ , number of modes are limited as  $\sin \theta$  cannot exceed unity for low value of  $m$ , value of  $\phi$  is low.
- On the other hand the value of  $\phi$  is more for higher order modes are due to steeper incident ray. What happens for  $\phi = 90^\circ$  the wave front bounces back and forth from both the walls without advancing along the axis.

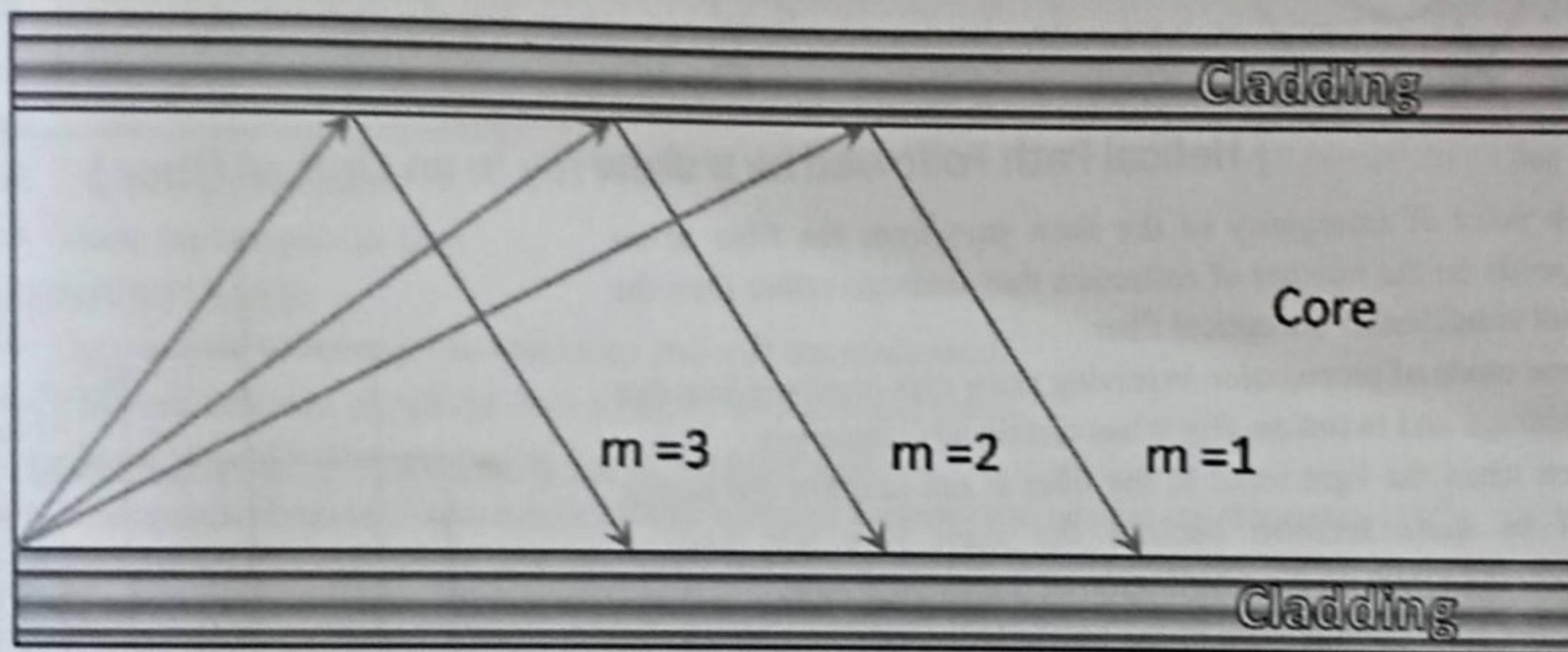

[ Mode Information in Step Index Fiber ]

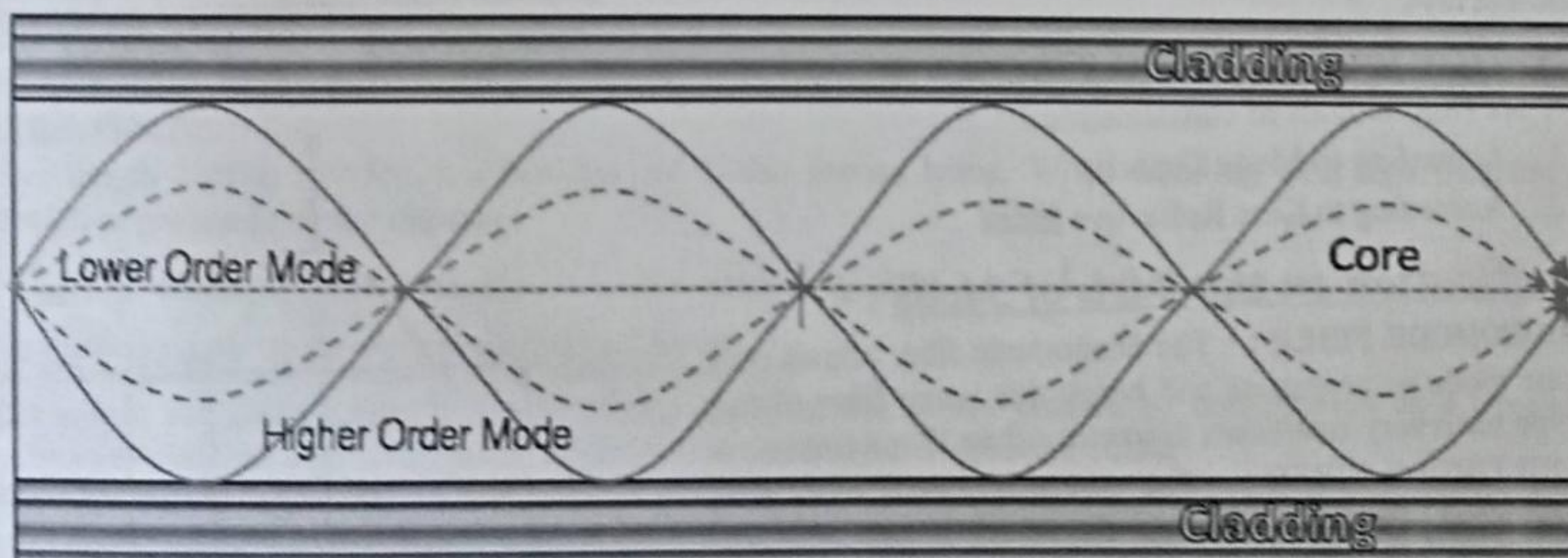

[ Mode Information in Graded Index Fiber ]

- When the fiber is very thin, the ray with a single low value of  $\phi$  i.e. grazing incidence can enter into the fiber the steeper ray with high value of  $\phi$  will not enter into the fiber.
- This is a monomode transmission if the core diameter is large, angle of incidence can change over a range and as such multimode transmission is possible as shown in figure above.

#### ❖ Meridional Rays and Skew Rays:-

- The rays propagating through an optical fiber can be divided into two groups. They are
  - Meridional Rays
  - Skew Rays

❖ Meridional Rays: -

➤ The rays said to be Meridional if all of them comprising a mode pass through the longitudinal of z-axis of fiber core, they are confined to a *single plane* which contain the axis of symmetry in below figure and therefore it is easy to trace its path in the fiber.

❖ Skew Rays: -

➤ The skew rays can propagate without passing through the axis of the fiber they are not contained to a *single plane* but follow a spiral or helical path due to reflection in different segment down to the fiber core in figure below. It is difficult to track the path of skew rays in the fiber.

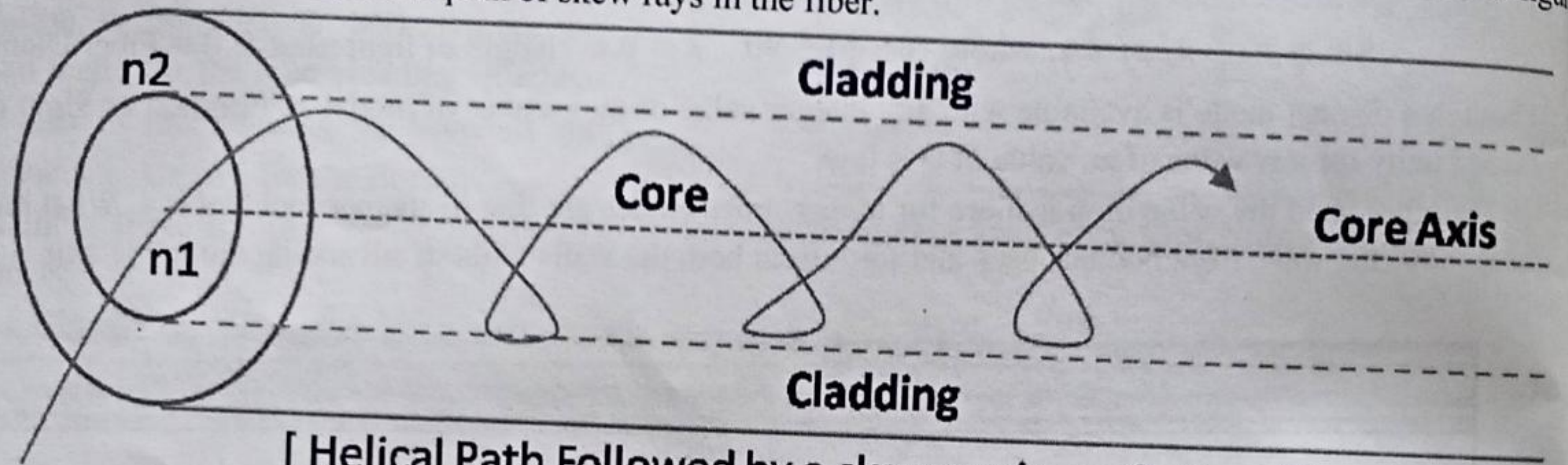

[ Helical Path Followed by a skew ray in an Optical Fiber ]

- The point of emergency of the skew rays from the fiber in air depends on the number of reflection they undergo rather than the input condition of the optical fiber.
- Some mode of propagation involving skew rays produces loss due to leakage and radiation. But it has certain advantage too.
- Even when the light input to the fiber is not uniform the output will be quite uniform because the skew rays will have a smoothing effect on the distribution of transmitted light.
- Another advantage feature of the transmission of the skew rays is that the effect numerical aperture will be greater than that for Meridional rays.

❖ Classification of Optical Fiber : -

- There are two methods of classification
  1. According to Mode Capacity
  2. According to Core Refractive Index

❖ Classification on the Basis of Mode : -

- A. **MONOMODE FIBER :** - The Monomode fiber allows only one mode to propagate and hence this name fiber of this type have very small core diameter ~ 2 to 10 micron.
- B. **MULTIMODE FIBER :** - The core diameter is more than 50micron. Because of large diameter, It allows many modes to transmit through the fiber.

❖ Classification on the Basis of Core Refractive Index:-

- A. **STEP INDEX FIBER:** - In step index fiber the core has uniform refractive index  $n_1$ , through its core section and the cladding also has slightly less but uniform refractive index  $n_2$  through its cross section. The refractive index profile, the figure shows a step like structure.
- B. **GRADED INDEX FIBER:-** Refractive index of the core is non-uniform being maximum along the axial and gradually decreases towards the core-cladding interface. The cladding refractive index  $n_2$ , however is uniform the variation of refractive index of the core  $n$  with distance 'x' measure from the axis.

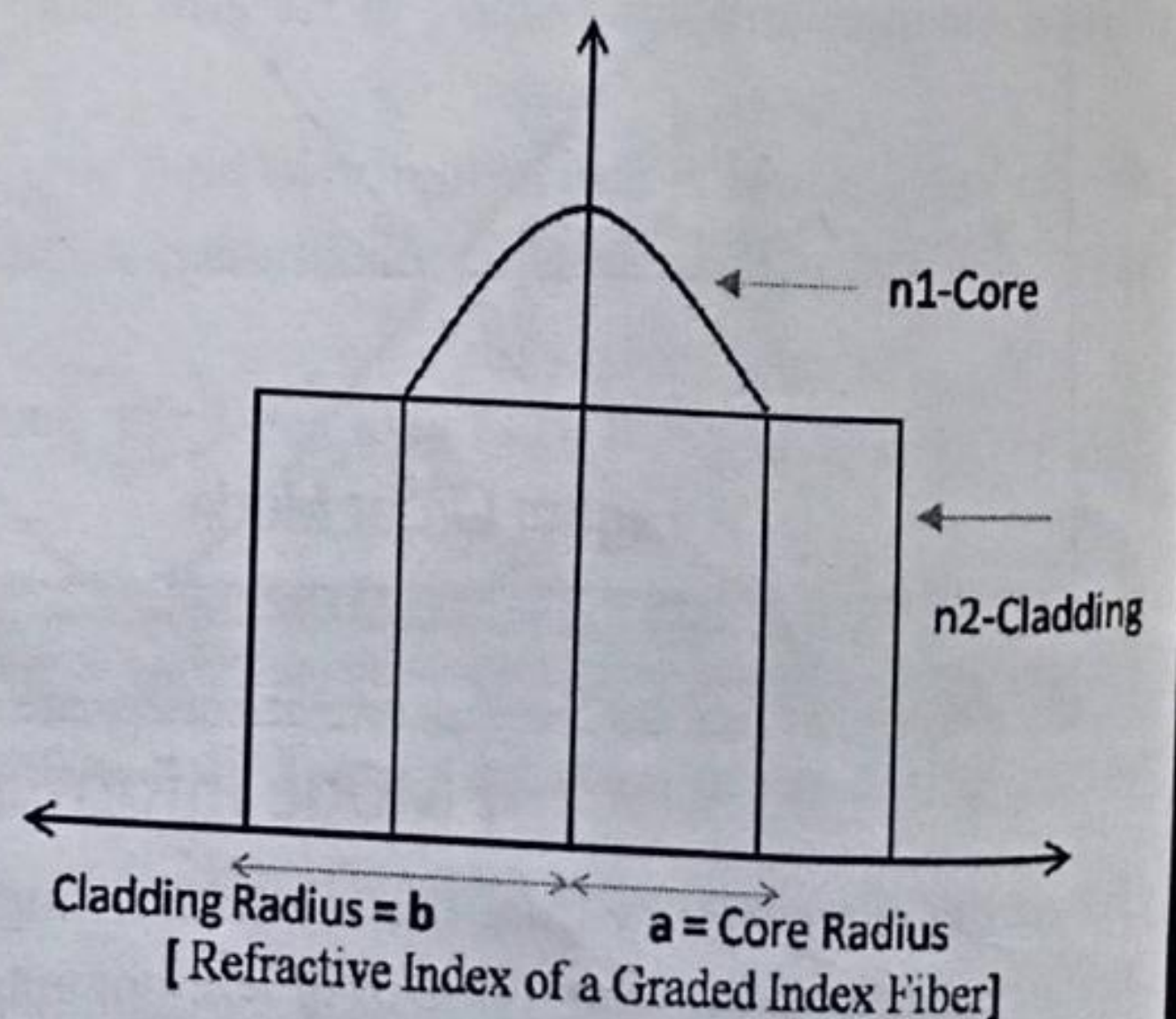
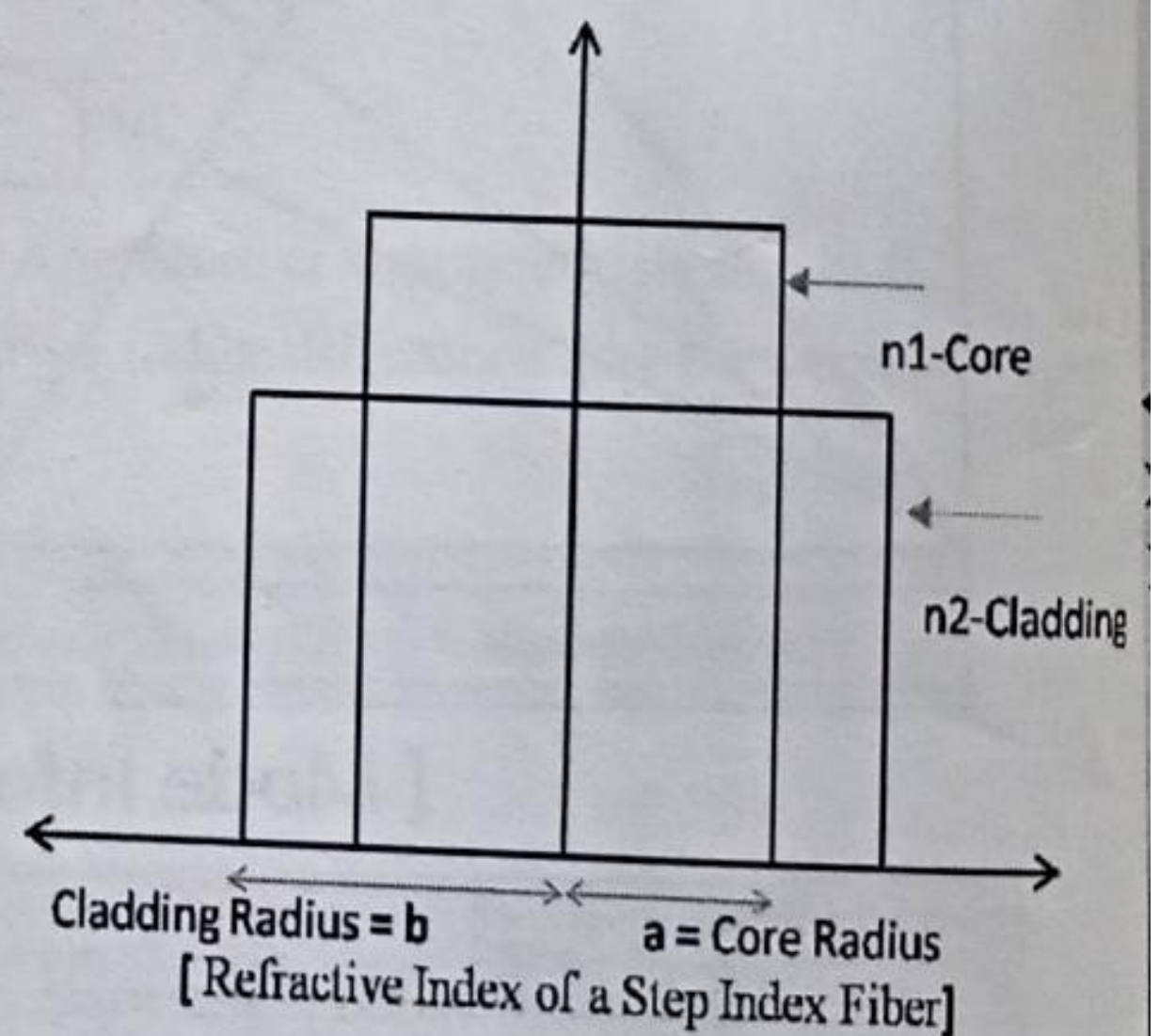



### ❖ Advantage and Disadvantage of Optical Fiber:-

➤ Communication through plastic fiber or glass fiber has several Advantages over metallic conductor.

#### 1. ADVANTAGES: -

- ↓ It has wider band width (10000 – 40000 GHz).
- ↓ It has higher information capacity having less resistance.
- ↓ It can transmit several G byte/sec with less resistance.
- ↓ It eliminates cross talk.
- ↓ It eliminates static interference.
- ↓ It eliminates environmental resistance and it is not effect of weather changes.
- ↓ It can be operated at thin temperature.
- ↓ Optical fiber cables are safer and easier to install.
- ↓ It is easy to storage due to flexibility in nature.
- ↓ It is lower transmission loss.
- ↓ It is more secure then metallic cable.
- ↓ It has higher durability.
- ↓ These are economic in nature.
- ↓ It is easy to transport.
- ↓ These are compact in size.

#### 2. DISADVANTAGES: -

- ↓ Optical fiber cable requires specialize tool and test equipment.
- ↓ The repairing cost of optical fiber is higher than metallic cable.

### ❖ Electromagnetic Frequency and Spectrum:-

- The electromagnetic frequency spectrum contains subsonic frequency to cosmic ray frequency ( $10^{22}$ ).
- The light frequency spectrum is divided into three bands: -

#### 1) INTRA RED:

These are the light which to have length in between Optical fiber system generally operated in the entire range or band.

#### 2) VISIBLE LIGHT:

The wave length between  $390 \times 10^{-9} \text{ m}$  –  $770 \times 10^9 \text{ m}$  is known as visible light which is visible to human being.

#### 3) ULTRA VIOLET:

Wave length 10NMt t 390NMt which are not visible human being. When detailing with high frequency the calculation are mode by the equation

$$\lambda = \frac{c}{f} \text{ Where } \lambda = \text{wave length, } C = \text{velocity of light, } f = \text{frequency}$$

### ❖ LED(LIGHT EMITTING DIODE):-

- LED stands for Light Emitting Diode. These types of diodes are created by combination of a trivalent or pentavalent material with some other material to produce light in different colour.

#### ❖ WORKING PRINCIPLE:-

- When these diodes are forward biased there is a process of recombination takes place due to which the free electrons release some energy in the form of light. The materials are so chosen that it creates a proton which is radiated by changing the energy gap and by adding some other materials different visible and invisible light are produced.
- LEDs are two types. Homo junction LED, Hetro junctio LED.

### ❖ INJECTION LASER DIODE (ILD):-

- It is constructed from either gases, liquid or solid. It is similar to the LED but at a specific threshold current it gives oscillations.
- As current passes in forward biased PM junction light emitted in spontaneous form with a determined frequency but where the threshold current reaches the minority carries due to which an opposite type of carrier is produced therefore these two different type of protons are stimulated by each other creating a huge light with huge current.

## [CHAPTER-III]

## SATELLITE COMMUNICATION

## 2.1 Satellite Orbital patterns and Elevation (LEO, MEO &amp; GEO) Categories

The use of satellites as platforms for remote sounding is based on some very fundamental physics: Newton's Laws of Motion and Gravitation (1686)

→ The basis for classical mechanics

**Laws of Motion:**

(1) Every body continues in its state of rest or of uniform motion in a straight line unless it is compelled to change that state by a force impressed upon it.

(2) The rate of change of momentum is proportional to the impressed force and is in the same direction as that force. Momentum = mass × velocity, so Law (2) becomes

$$\dot{p} = \frac{d(mv)}{dt} = m \frac{dv}{dt} = ma$$

(3) For every action, there is an equal and opposite reaction.

**Law of Gravitation:** The force of attraction between any two particles is

- Proportional to their masses
- Inversely proportional to the square of the distance between them

$$F = \frac{Gm_1m_2}{r^2}$$

(Treating the masses as points)

Where  $G$  = gravitational constant =  $6.673 \times 10^{-11} \text{ Nm}^2/\text{kg}^2$

**These laws explain how a satellite stays in orbit.**

Law (1): A satellite would tend to go off in a straight line if no force were applied to it.

Law (2): An attractive force makes the satellite deviate from a straight line and orbit Earth.

Law of Gravitation: This attractive force is the gravitational force between Earth and the satellite. Gravity provides the inward pull that keeps the satellite in orbit. Assuming a circular orbit, the gravitational force must equal the centripetal force.

$$\frac{mv^2}{r} = \frac{Gmm_E}{r^2}$$

Where

$v$  = tangential velocity

$r$  = orbit radius =  $R_E + h$  (i.e. not the altitude of the orbit)

$R_E$  = radius of Earth

$h$  = altitude of orbit = height above Earth's surface

$m$  = mass of satellite

$m_E$  = mass of Earth

$$v = \sqrt{\frac{GM_E}{r}}$$

So  $v$  depends only on the altitude of the orbit (not on the satellite's mass).

The period of the satellite's orbit is

$$T = \frac{2\pi r}{v} = 2\pi r \sqrt{\frac{r}{GM_E}} = 2\pi \sqrt{\frac{r^3}{GM_E}}$$

Again, this is only dependent on the altitude, increasing as the orbit's altitude increases.

$$\frac{\Delta v}{v} = \frac{v \Delta t}{r}, \text{ so } a = \lim_{\Delta t \rightarrow 0} \frac{\Delta v}{\Delta t} = \frac{v^2}{r}$$

The acceleration of the satellite is determined using

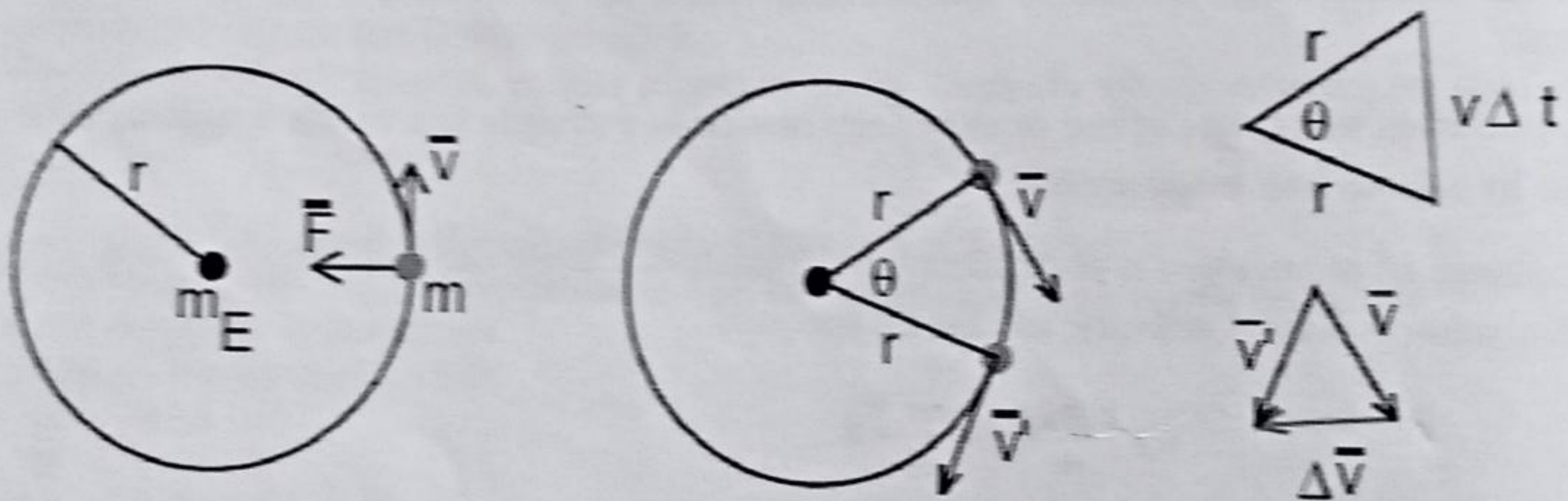

### Kepler's Laws for Orbits

So far, we have assumed that satellites travel in circular orbits, but this is not necessarily true in practice. Newton's Laws can be used to derive the exact form of a satellite's orbit.

However, a simpler approach is to look at Kepler's Laws, which summarize the results of the full derivation. Kepler's Laws (1609 for 1,2; 1619 for 3) were based on observations of the motions of planets.

- (1) All planets travel in elliptical orbits with the Sun at one focus.  
→ defines the shape of orbits
- (2) The radius from the Sun to the planet sweeps out equal areas in equal times.  
→ determines how orbital position varies in time
- (3) The square of the period of a planet's revolution is proportional to the cube of its semi major axis.  
→ suggests that there is some systematic factor at work

For satellites, substitute "satellite" for planet, and "Earth" for Sun.

### ORBITAL ELEVATION (LEO, MEO & GEO) CATEGORIES

#### LEO Basics (Lower Earth Orbit)

With Low Earth Orbit extending from 200 km to 1200 km it means that it is relatively low in altitude, although well above anything that a conventional aircraft can reach.

However LEO is still very close to the Earth, especially when compared to other orbits including geostationary orbit.

The low orbit altitude of leads to a number of characteristics:

- Orbit times are much less than for many other forms of orbit. The lower altitude means higher velocities are required to balance the earth's gravitational field. Typical velocities are very approximately around 8 km/s, with orbit times sometimes of the order of 90 minutes, although these figures vary considerably with the exact details of the orbit.
- The lower orbit means the satellite and user are closer together and therefore path losses a less than for other orbits such as GEO
- The round trip time, RTT for the radio signals is considerably less than that experienced by geostationary orbit satellites. The actual time will depend upon factors such as the orbit altitude and the position of the user relative to the satellite.
- Radiation levels are lower than experienced at higher altitudes.
- Less energy is expended placing the satellites in LEO than higher orbits.
- Some speed reduction may be experienced as a result of friction from the low, but measurable levels of gasses, especially at lower altitudes. An altitude of 300 km is normally accepted as the minimum for an orbit as a result of the increasing drag from the presence of gasses at low altitudes.

### Applications for LEO Satellites

A variety of different types of satellite use the LEO orbit levels. These include different types and applications including:

- Communications satellites - some communications satellites including the Iridium phone system use LEO.
- Earth monitoring satellites use LEO as they are able to see the surface of the Earth more clearly as they are not so far away. They are also able to traverse the surface of the Earth.
- The International Space Station is in an LEO that varies between 320 km (199 miles) and 400 km (249 miles) above the Earth's surface. It can often be seen from the Earth's surface with the naked eye.

### MEO Basics (Middle Earth Orbit)

A medium earth orbit (MEO) satellite is one with an orbit within the range from a few hundred miles to a few thousand miles above the earth's surface. Satellites of this type orbit higher than low earth orbit (LEO) satellites, but lower than geostationary satellites.

The orbital periods of MEO satellites range from about two to 12 hours. Some MEO satellites orbit in near perfect circles, and therefore have constant altitude and travel at a constant speed.

Other MEO satellites revolve in elongated orbits. The perigee (lowest altitude) of an elliptical-orbit satellite is much less than its apogee (greatest altitude). The orbital speed is much greater near perigee than near apogee.

As seen from a point on the surface, a satellite in an elongated orbit crosses the sky in just a few minutes when it is near perigee, as compared to several hours when it is near apogee.

Elliptical-orbit satellites are easiest to access near apogee, because the earth-based antenna orientation does not have to be changed often, and the satellite is above the horizon for a fairly long time.

A fleet of several MEO satellites, with orbits properly coordinated, can provide global wireless communication coverage. Because MEO satellites are closer to the earth than geostationary satellites, earth-based transmitters with relatively low power and modest-sized antennas can access the system.

Because MEO satellites orbit at higher altitudes than LEO satellites, the useful footprint (coverage area on the earth's surface) is greater for each satellite. Thus a global-coverage fleet of MEO satellites can have fewer members than a global-coverage fleet of LEO satellites.

One very popular orbit format is the geostationary satellite orbit. The geostationary orbit is used by many applications including direct broadcast as well as communications or relay systems.

The geostationary orbit has the advantage that the satellite remains in the same position throughout the day, and antennas can be directed towards the satellite and remain on track.

This factor is of particular importance for applications such as direct broadcast TV where changing directions for the antenna would not be practicable.

It is necessary to take care over the use of the abbreviations for geostationary orbit. Both GEO and GSO are seen, and both also used for geosynchronous orbit.

### GEO (Geo stationary Earth Orbit)

The idea of a geostationary orbit has been postulated for many years. One of the possible originators of the basic idea was a Russian theorist and science fiction writer, Konstantin Tsiolkovsky.

However it was Herman Oberth and Herman Potochnik who wrote about orbiting stations at an altitude of 35 900 km above the Earth that had a rotational period of 24 hours making it appear to hover over a fixed point on the equator.

The next major step forwards occurred when Arthur C Clarke, the science fiction write, published a serious article in *Wireless World*, a major UK electronics and radio publication, in October 1945. The article was entitled "Extra-Terrestrial Relays: Can Rocket Stations Give World Coverage?"

Clarke extrapolated what could be done with the German rocket technology of the day and looked at what might be possible in the future. He postulated that it would be possible to provide complete global coverage with just three geostationary satellites.

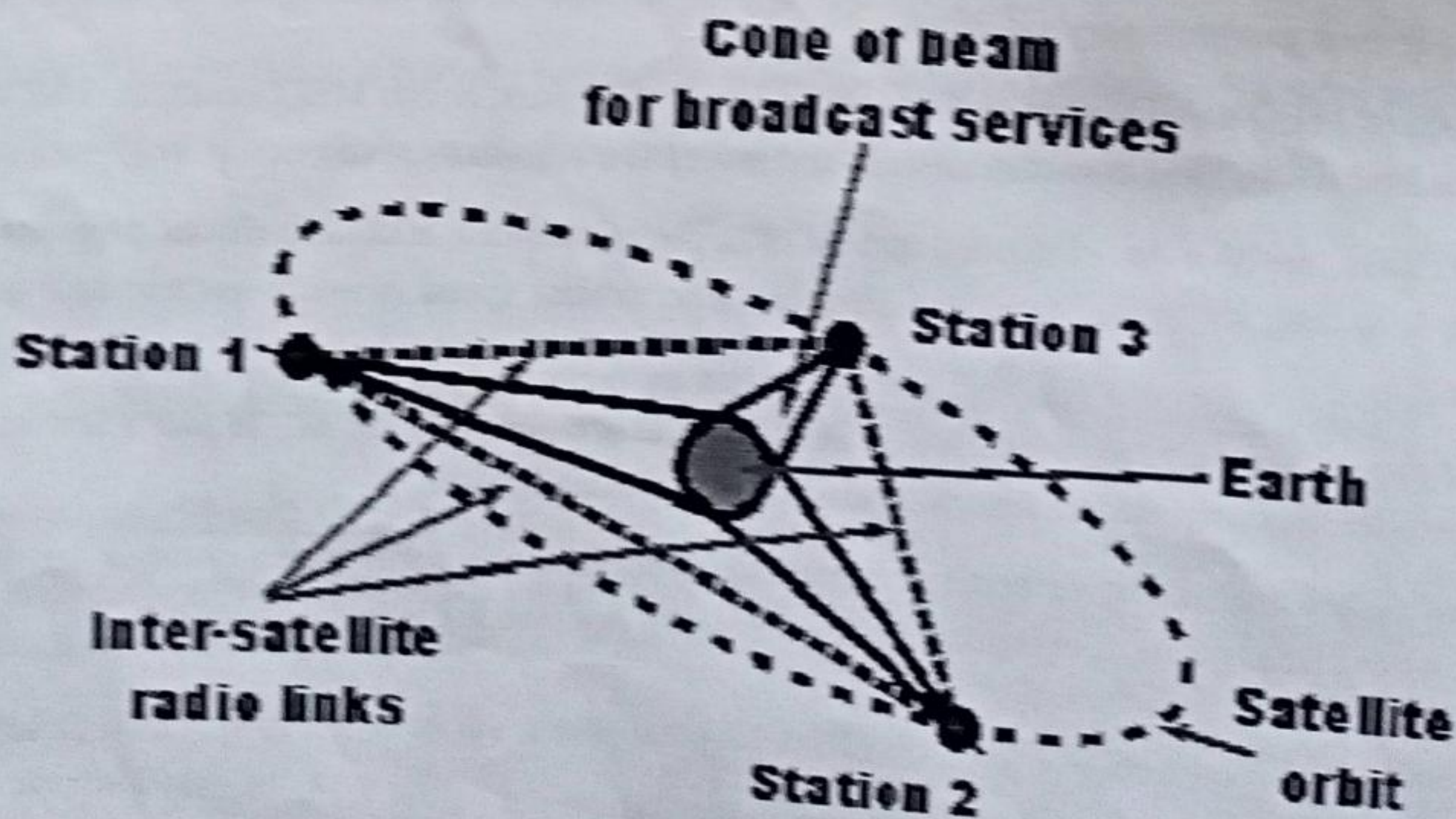

## 2.2 The Concept of Geostationary Satellite , calculate its height, velocity & round trip time delay & their advantage & disadvantage over other system

### Geostationary Orbit basics

As the height of a satellite increases, so the time for the satellite to orbit increases. At a height of 35790 km, it takes 24 hours for the satellite to orbit. This type of orbit is known as a geosynchronous orbit, i.e. it is synchronized with the Earth.

One particular form of geosynchronous orbit is known as a geostationary orbit. In this type of orbit the satellite rotates in the same direction as the rotation of the Earth and has an approximate 24 hour period. This means that it revolves at the same angular velocity as the Earth and in the same direction and therefore remains in the same position relative to the Earth.

In order to ensure that the satellite rotates at exactly the same speed as the Earth, it is necessary to clarify exactly what the time is for the rotation of the Earth. For most timekeeping applications, the Earth's rotation is measured relative to the Sun's mean position, and the rotation of the earth combined with the rotation around the Sun provide the length of time for a day. However this is not the exact rotation that we are interested in to give a geostationary orbit - the time required is just that for one rotation. This time period is known as a sidereal day and it is 23 hours 56 minutes and 4 seconds long.

Geometry dictates that the only way in which an orbit that rotates once per day can remain over exactly the same spot on the Earth's surface is that it moves in the same direction as the earth's rotation. Also it must not move north or south for any of its orbit. This can only occur if it remains over the equator.

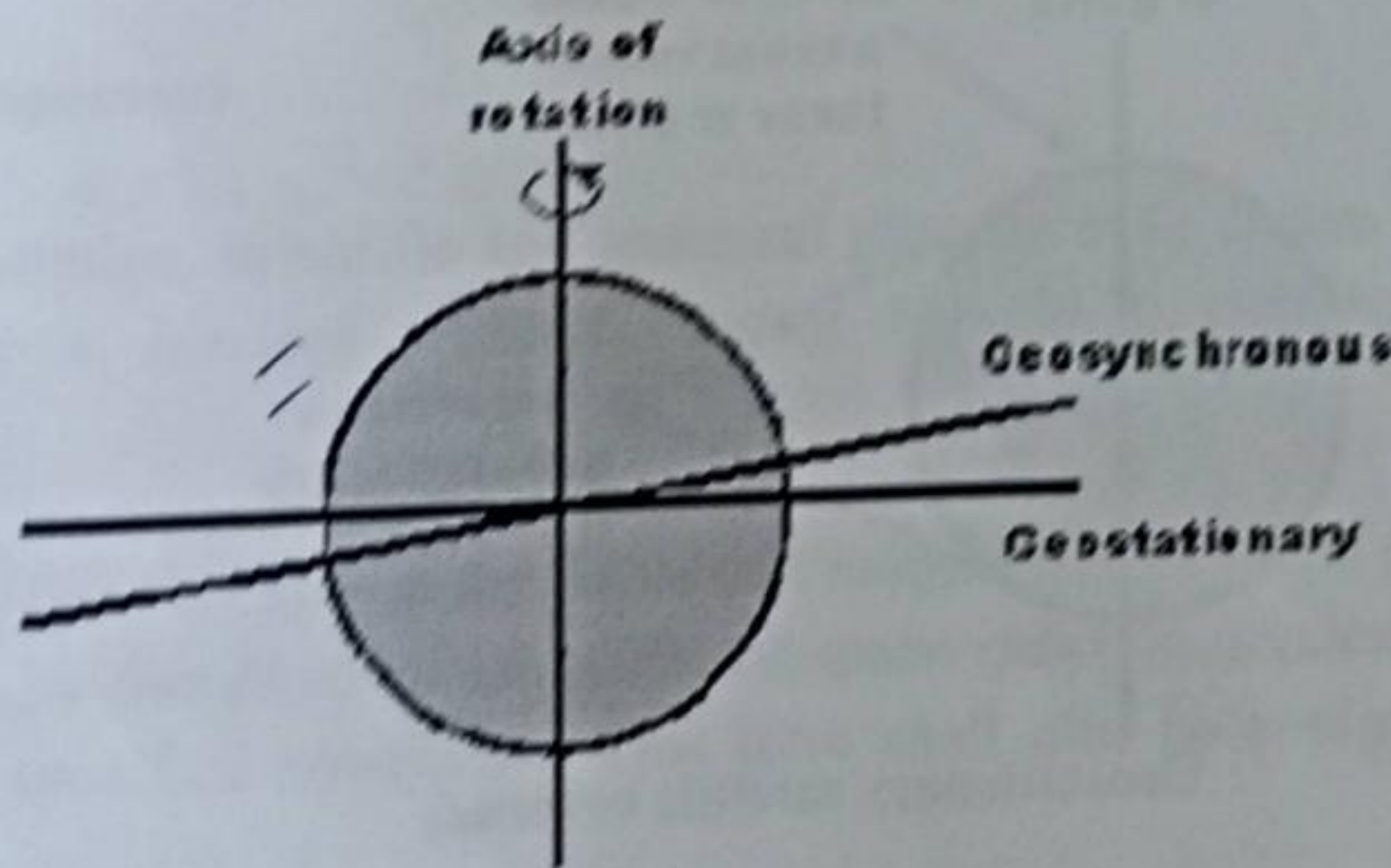

**Geostationary orbit can only be over the Equator**

Different orbits can be seen from the diagram. As all orbital planes need to pass through the geo-centre of the Earth, the two options available are shown. Even if both orbits rotate at the same speed as the Earth, the one labelled geosynchronous will move north of the equator for part of the day, and below for the other half - it will not be stationary. For a satellite to be stationary, it must be above the Equator.

### Geostationary Satellite Drift

Even when satellites are placed into a geostationary orbit, there are several forces that can act on it to change its position slowly over time.

Factors including the earth's elliptical shape, the pull of the Sun and Moon and others act to increase the satellite orbital inclination.

In particular the non-circular shape of the of the Earth around the Equator tends to draw the satellites towards two stable equilibrium points, one above the Indian Ocean and the other very roughly around the other side of the World.. This results in what is termed as an east-west libration or movement back and forth.

To overcome these movements, fuel is carried by the satellites to enable them to carry out "station-keeping" where the satellite is returned to its desired position. The period between station-keeping manoeuvres is determined by the allowable tolerance on the satellite which is mainly determined by the ground antenna beamwidth. This will mean that no re-adjustment of the antennas is required.

Often the useful life of a satellite is determined by the time for which fuel will allow the station-keeping to be undertaken. Often this will be several years. After this the satellite can drift towards one of the two equilibrium points, and possibly re-enter the Earth's atmosphere. The preferred option is for the satellites to utilise some last fuel to lift them into a higher and increasing orbit to prevent them from interfering with other satellites.

### Geostationary Orbit Coverage

A single geostationary satellite obviously cannot provide complete global coverage. However, a single geostationary satellite can see approximately 42% of the Earth's surface with coverage falling off towards the satellite is not able to "see" the surface. This occurs around the equator and also towards the polar regions.

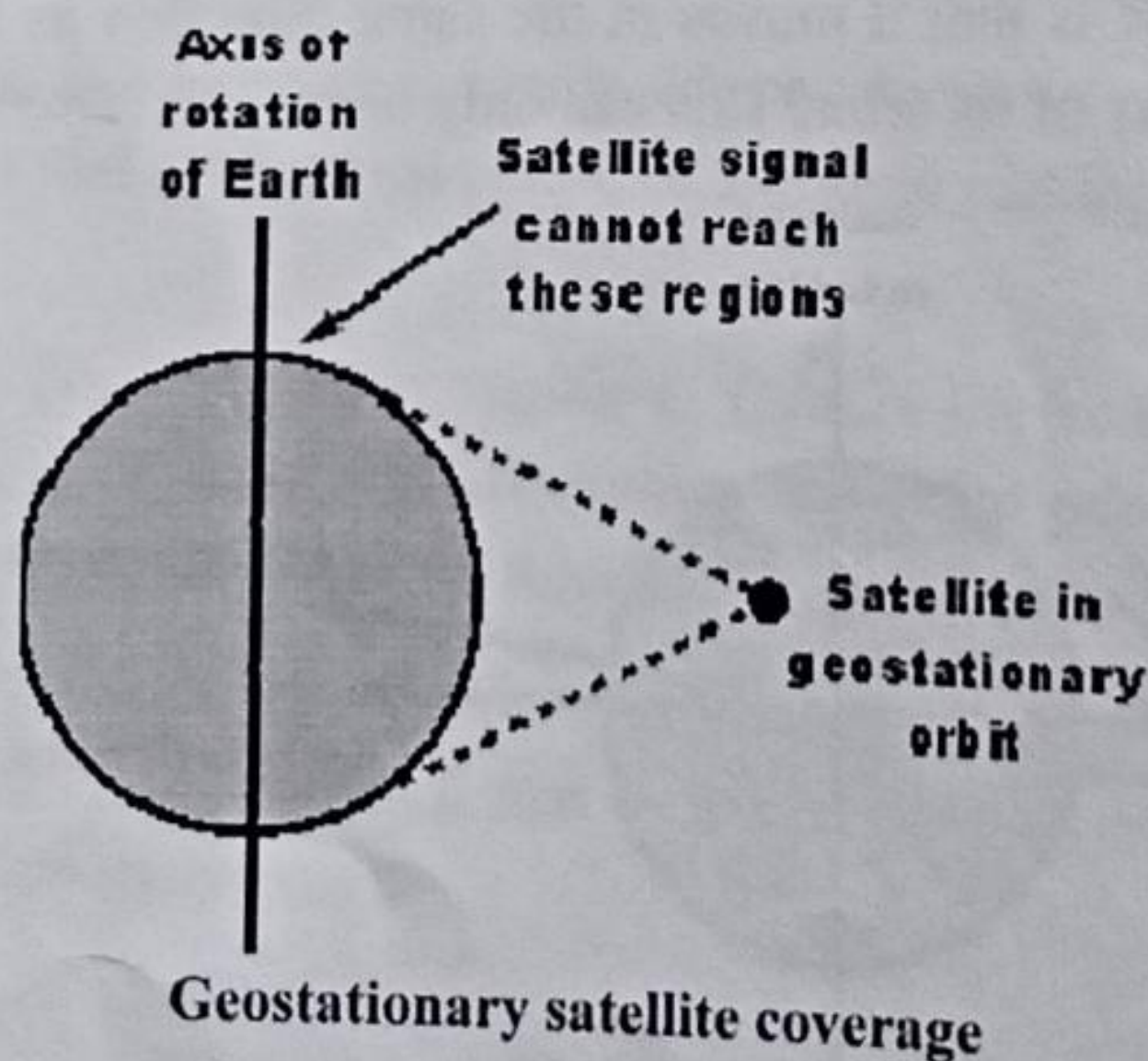

For a constellation of three satellites equally spaced around the globe, it is possible to provide complete coverage around the equator and up to latitudes of  $81^\circ$  both north and south.

The lack of polar coverage is not a problem for most users, although where polar coverage is needed, satellites using other forms of orbit are needed.

### Height, velocity & round trip time delay

Height of GEO satellite can be given as

$$r \text{ (orbit radius)} = R_E \text{ (Radius of the Earth)} + h$$

Round trip time delay is given as following

$$T = \frac{2\pi r}{v} = 2\pi r \sqrt{\frac{r}{Gm_E}} = 2\pi \sqrt{\frac{r^3}{Gm_E}}$$

Regulations of the International Telecommunication Union (ITU) as well as by the bilateral agreements between two countries.

- All frequency bands are available for use in all countries, including India, in accordance with international table of Frequency allocations and associated radio regulatory provisions. National Frequency Allocation Plan forms the basis for development, manufacturing and spectrum utilisation activities in the country.

#### Frequency Allocations For Satellite Services or Fixed Satellite Service (FSS) (Frequency Bands)

5925-6425 MHz FOR UP-LINK (C-BAND)
3700-4200 MHz FOR DOWNLINK (C BAND)
6725-7075 MHz FOR UPLINK (UPPER EXT C)
4500-4800 MHz FOR DOWNLINK (UPPER EXT C)
6425-6725 MHz FOR UPLINK (LOWER EXT-C)
3400-3700 MHz FOR DOWNLINK (LOWER EXT-C)
10.95 - 11.2 GHz (down-links)
11.45 - 11.7 GHz (down-links)
11.7 - 12.2 GHz (down-links) (Region 2 only)
12.5 - 12.75 GHz (down-links) (Region 1 only)
14.0 - 14.5 GHz (up-links)
17.7 - 21.2 GHz (down-links)
27.5 - 31.0 GHz (up-links)

### 2.4 General structure of satellite Link system (Uplink, Down link, Transponder, Crosslink)

#### DIGITAL SATELLITE UPLINK CHAIN

1. Digital data is sent to the modulator which takes the data and converts it into a modulated signal in the Intermediate Frequency range (70-140 Mhz). The modulators use standards such as *Digital Video Broadcast* to organize communication over the microwave link.
2. The *Intermediate Frequency* is piped to an "up converter" (usually via shielded coaxial cable) which mixes the *intermediate frequency* with a higher frequency to produce a final frequency which carries the modulated data.
3. Noise is removed from the signal via either a band pass filter or other means and then it is amplified in a Klystron, Travelling Wave Tube or Solid State amplifier.
4. The final cleaned signal is transmitted down the wave guide to the dish.
5. The *feed horn* at the focal point of the dish emits the high frequency radio transmission, which the dish focuses into a directional transmission at the satellite.
6. Computer data is sent through a serial cable to a modulator. The modulator takes the data and produces a radio frequency from it. This frequency is usually in what is called the 'L-band' range (70-140Mhz). The modulator passes the information over coaxial cable to an 'up converter', which converts the radio frequency from 'L-band' up to microwave frequencies in the C, S, X, Ka, and Ku band ranges (frequencies above 1,000 Mhz). Once the final signal has been produced, it's amplified to increase its total effective output power. The signal is then sent out a dish via the feed horn.



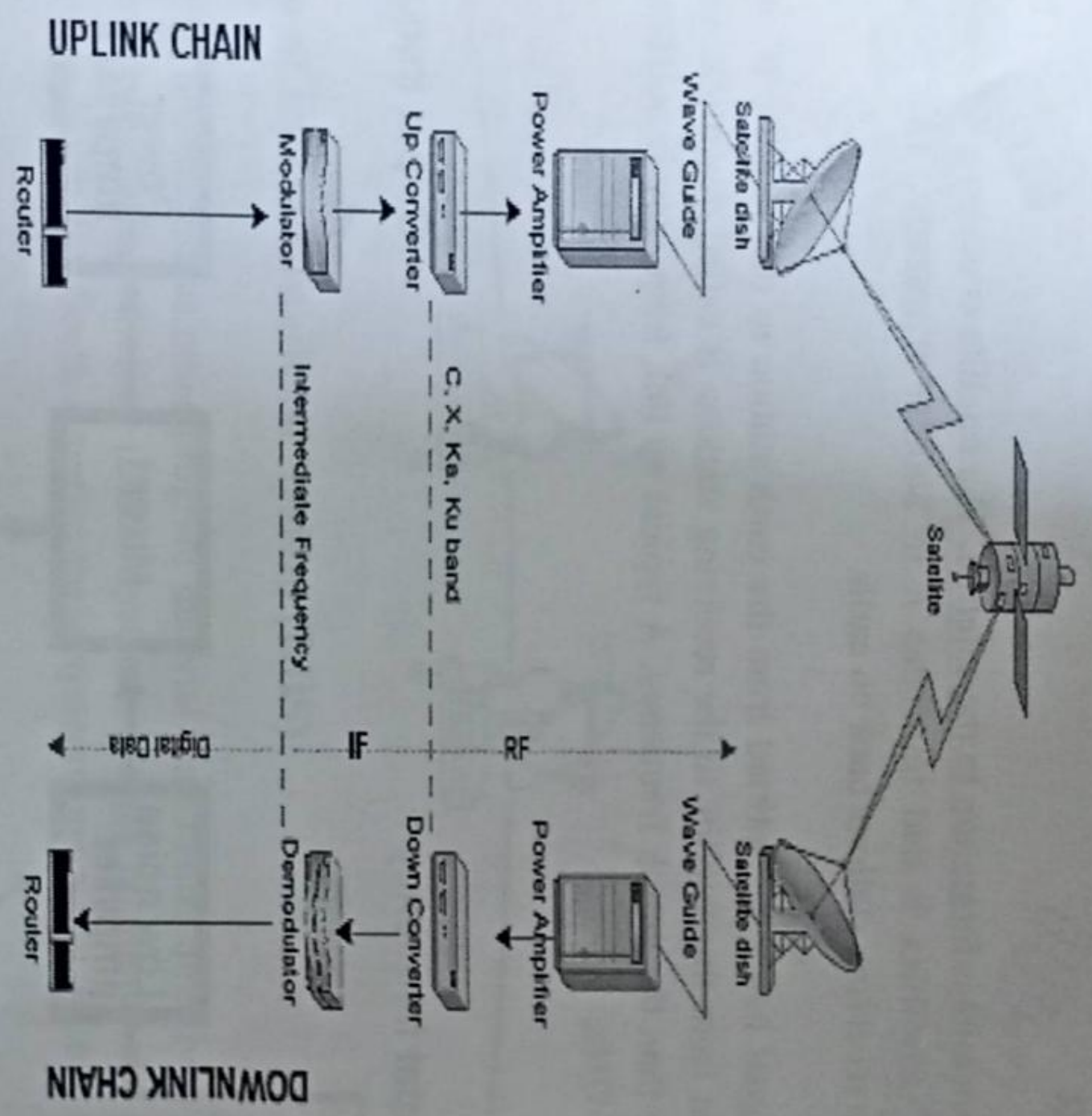

### DOWNLINK CHAIN

Downlink is a telecommunication term pertaining to data which is sent out or downwards from a higher level or portion of a network.

Traditionally, it refers to a satellite communications process where data is sent from a satellite down to an earthbound terminal or device, hence the word "down."

It is also used in other fields of networking like cellular and computer networking, where it is used in a similar manner but may or may not involve the directional meaning of up or down.

In satellite communications, downlink simply refers to the process when a satellite beams down information toward earthbound terminals or devices. The opposite of this is uplink, where the satellite receives data from an earthbound terminal.

In cellular networking, downlink can be seen from the user perspective as receiving some sort of message or data. A cellular device or phone receives direct communication from a cellular base station.

An example of this is receiving a text message or an image from someone—that message is received through a downlink communication process.

The term is used in the same way in computer networking. Edge terminals or nodes receive data from the network core or from higher-level network nodes such as routers and servers, and is commonly known as downloading. Therefore, the downloading of images and videos is done through the downlink process.

### TRANSPONDER

An earth station transmits information to the satellite. The satellite contains a receiver, which picks up the transmitted signal, amplifies it and translates it to another frequency. This new frequency is then retransmitted to the receiving stations back on earth.

The original signal being transmitted from the earth station to the satellite is called the uplink. The retransmitted signal from the satellite to the receiving stations is called downlink. Usually the downlink frequency is lower than the uplink frequency. A typical uplink frequency is 6GHz and a common downlink frequency is 4 GHz.

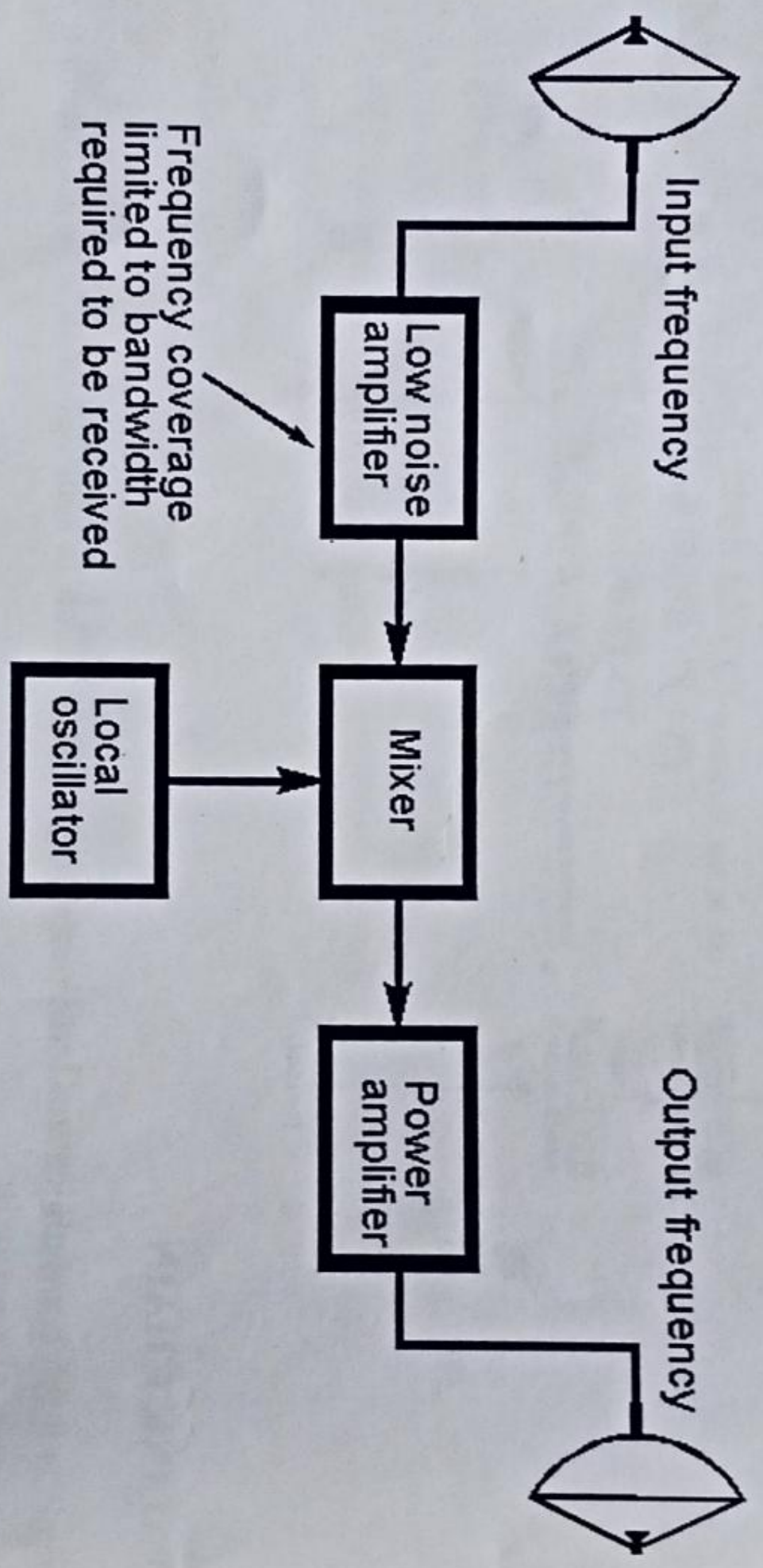

The transmitter – receiver combination in the satellite is known as **transponder**. The basic function of a transponder is amplification and frequency translation.

The reason for frequency translation is that the transponder cannot transmit and receive on the same frequency. Transponders are wide bandwidth units so that they may receive and retransmit more than one signal. An amplified, translated and receiver's bandwidth will be amplified, translated and retransmitted on a different frequency.

Even though the typical transponder has a wide bandwidth, it is only used with a single signal to minimize interference and improve communications reliability. Most satellites contain multiple transponders, each operating at a different frequency.

A typical communications satellite has 12, 2 or more transponders. Each transponder represents an individual communications channel.

### CROSSLINK

A crosslink is when satellites communicate directly with each other, instead of communicating with a ground station which, in turn, communicates with other satellites. Frequencies that are quickly attenuated in the atmosphere are commonly used, making the link undetectable and unjamable from the ground.

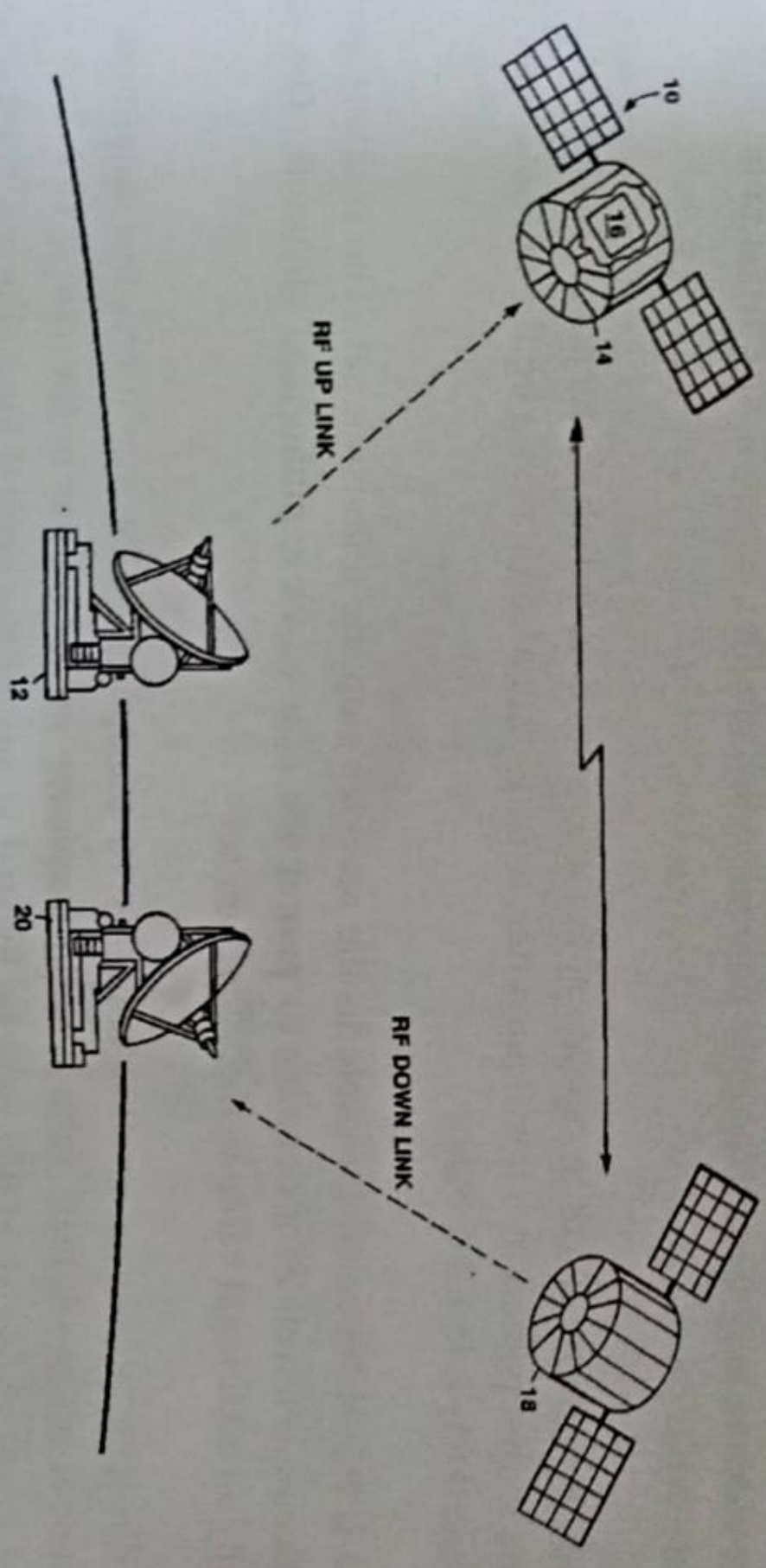

### 2.5 The operation of Direct Broadcast System (DBS)

Systems for transmitting television and other program material via satellite directly to individual homes and businesses. Direct broadcasting satellite (DBS) systems operate at microwave frequencies, in a portion of the Ku band; in North and South America these systems operate in the frequency range 12.2-12.7 GHz.

Although direct broadcasting satellites had been operating in Europe and Japan for a number of years, the first United States direct broadcasting satellite was launched on December 17, 1993, and the second in July 1994, followed by additional satellites in subsequent years.

DBS systems use a satellite in geostationary orbit to receive television signals sent up from the Earth's surface, amplify them, and transmit them back down to the surface. The satellite also shifts the signal frequency, so that a signal sent up to the satellite in the 17.3-17.8-GHz uplink band is transmitted back down in the 12.2-12.7-GHz downlink band. The downlink signal is picked up by a receive antenna located atop an individual home or office; these antennas are usually in the form of a parabolic dish, but flat square phased-array antennas are sometimes used, and may eventually become commonplace.

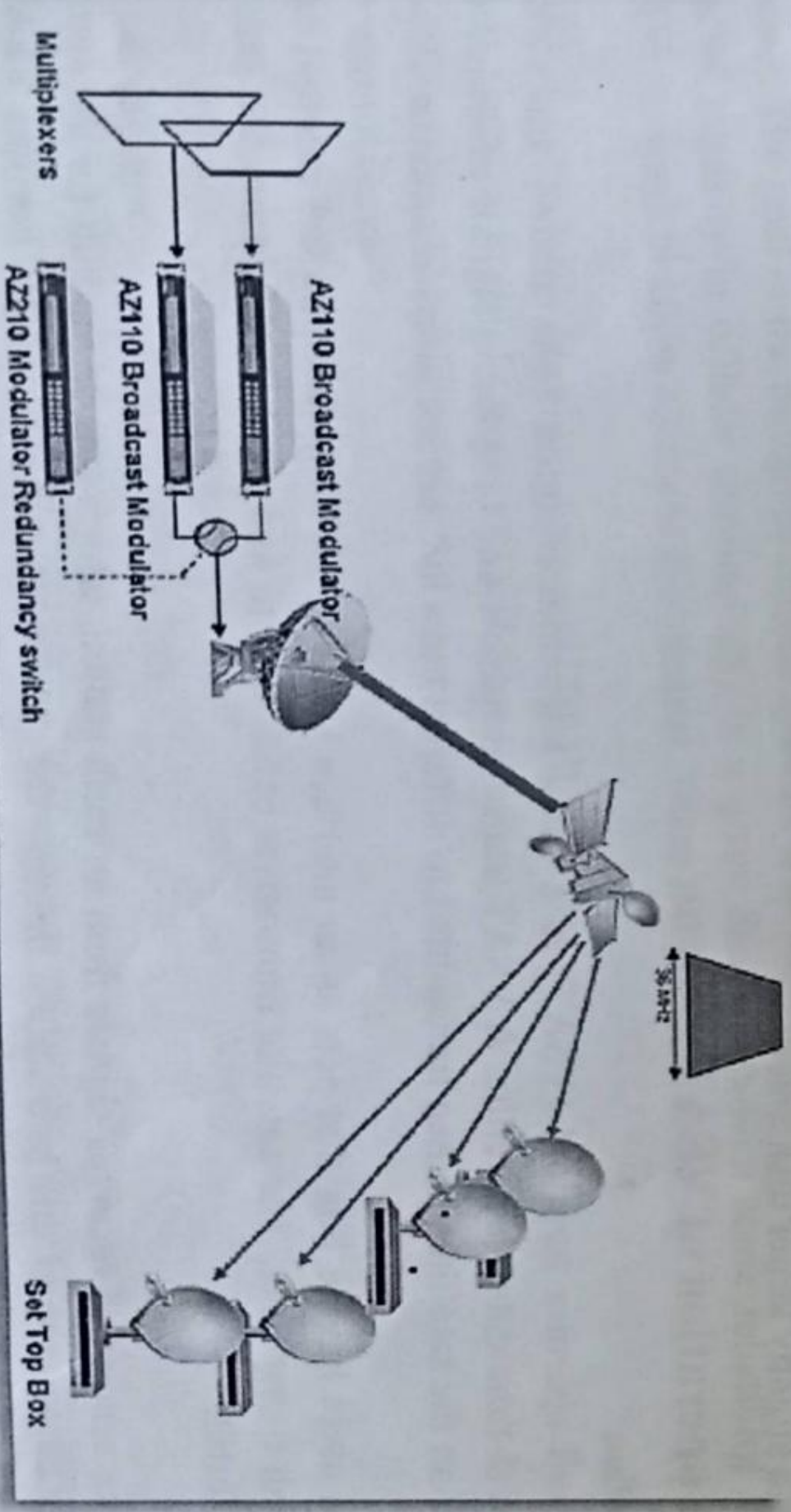

Then the satellite sends the data to the hub station for further processing. The data is then retransmitted to the other user via a satellite. The majority of VSAT antennas range from 30 inches to 48 inches. Data rates typically range from 56 Kbps up to 4 Mbps.

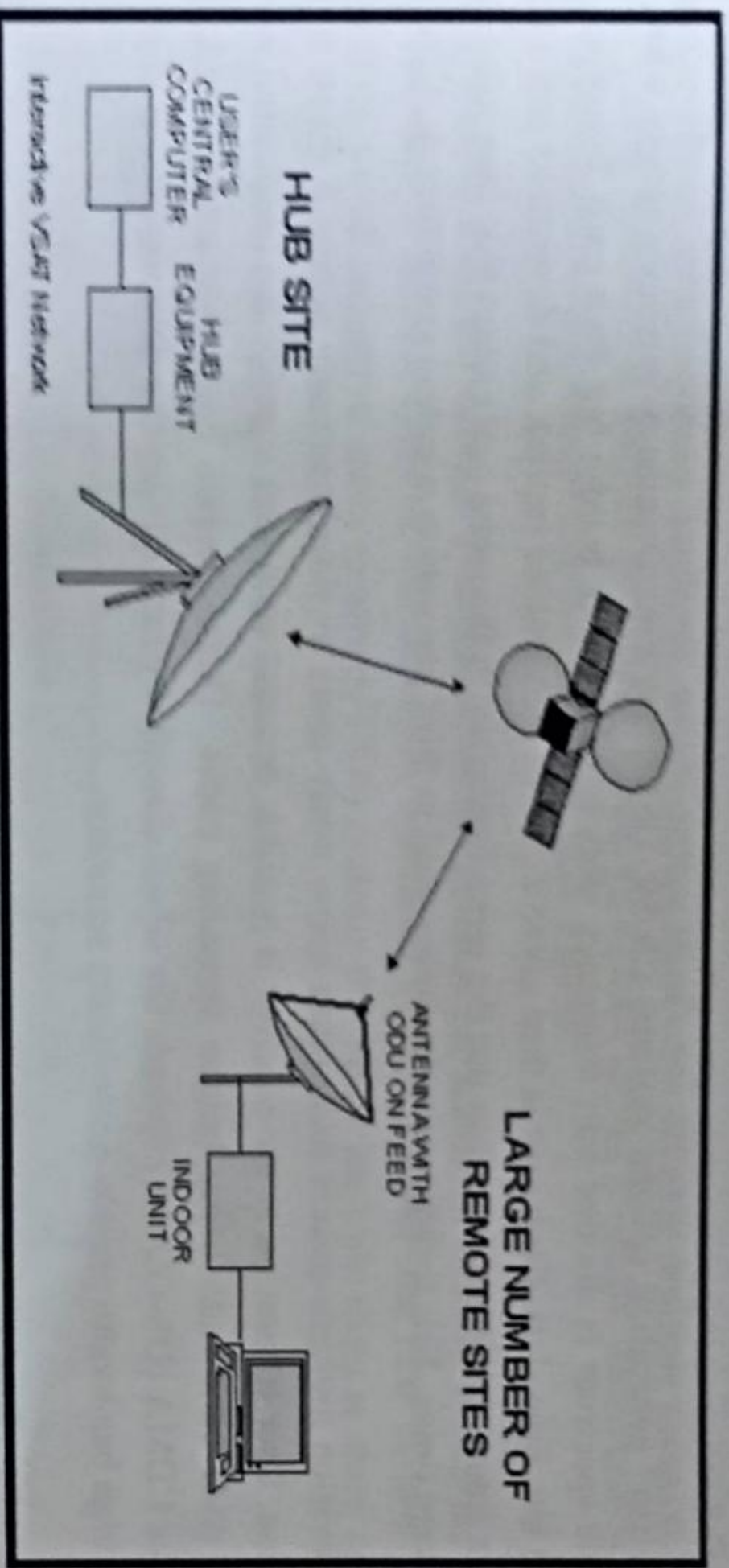

VSATs are most commonly used to transmit:

- Narrowband data. This includes point of sale transactions such as credit card, polling or radio-frequency identification (RFID) data, or supervisory control and data acquisition (SCADA) data
- Broadband data, for the provision of satellite Internet access to remote locations, Voice over Internet Protocol (VoIP) or video

VSATs are also used for transportable, on-the-move communications (using phased array antennas) and mobile maritime communications.

### 2.7 Define multiple accessing & name various types.

#### MULTIPLE-ACCESS TECHNIQUES

Cellular systems divide a geographic region into cells where a mobile unit in each cell communicates with a base station. The goal in the design of cellular systems is to be able to handle as many calls as possible (this is called capacity in cellular terminology) in a given bandwidth with some reliability. There are several different ways to allow access to the channel. These include the following.

- Frequency Division Multiple-Access (FDMA)
- Time Division Multiple-Access (TDMA)
- Time/Frequency Multiple-Access
- Random Access
- Code Division Multiple-Access (CDMA)
  - Frequency-Hop CDMA
  - Direct-Sequence CDMA
  - Multi-Carrier CDMA (FH or DS)

As mentioned earlier, FDMA was the initial multiple-access technique for cellular systems. In this technique a user is assigned a pair of frequencies when placing or receiving a call.

One frequency is used for downlink (base station to mobile) and one pair for uplink (mobile to base). TDMA allows is called frequency division duplexing. That frequency pair is not used in the same cell or adjacent cells during the call. Even though the user may not be talking, the spectrum cannot be reassigned as long as surrounding frequency is in place.

Two second generation cellular systems (IS-54, GSM) use time/frequency multiple-access whereby the available spectrum is divided into frequency slots (e.g., 30 KHz bands) but then each frequency slot is further divided into time slots. Each user is then given a pair of frequencies (uplink and downlink) and a time slot during a frame. Different users can use the same frequency in the same cell except that they must transmit at different times. This technique is also being used in third generation wireless systems (e.g., EDGE).

Code division multiple-access techniques allow many users to simultaneously access a given frequency slot. User separation at the receiver is possible because each user spreads the modulated waveform over a wide bandwidth using unique spreading codes. There are two basic types of CDMA. Direct sequence CDMA (DS-SS) spreads the signal directly by multiplying the data waveform with a unique high bandwidth pseudo-noise binary sequence.

The resulting signal is then mixed up to a carrier frequency and transmitted. The receiver mixes down the baseband and then re-multiplies with the binary  $\{\pm 1\}$  pseudo-noise sequence. This effectively (assuming perfect synchronization) removes the pseudo-noise signal and what remains (of the desired signal) is the transmitted data waveform. After removing the pseudo-noise signal, a filter with bandwidth proportional to the data rate is applied to the signal. Because other users do not use completely orthogonal spreading codes, there is residual multiple-access interference present at the filter output.

This multiple-access interference can present a significant problem if the power level of the desired signal is significantly lower (due to distance) than the power level of the interfering user. This is called the near-far problem. Over the last 15 years there has been considerable theoretical research on solutions to this near-far problem beginning with the derivation of the optimal multiuser receiver and now with multiuser receivers (e.g., Fujitsu, NTT DoCoMo, NEC) building suboptimal reduced complexity multiuser receivers. The approach being considered by companies is either successive interference cancellation or parallel interference cancellation.

One advantage of these techniques is that they generally do not require spreading codes with period equal to the bit duration. Another advantage is that they do not require significant complexity (compared to minimum mean square error-MMSE-detector or a decorrelating detector). These interference cancellation detectors can also easily be improved by cascading several stages together.

**2.8 Time Division Multiple Accessing (TDMA) & its advantages & Disadvantages.**

Time division multiple access (TDMA) is a channel access method (CAM) used to facilitate channel sharing without interference. TDMA allows multiple stations to share and use the same transmission channel by dividing signals into different time slots.

Users transmit in rapid succession, and each one uses its own time slot. Thus, multiple stations (like mobiles) may share the same frequency channel but only use part of its capacity. Examples of TDMA include IS-136, personal digital cellular (PDC), integrated digital enhanced network (IDEN) and the second generation (2G) Global System for Mobile Communications (GSM).

**Advantages**

- TDMA allows multiple users to share a common channel.
- TDMA provides better security than FDMA.
- TDMA allows for more efficient use of the spectrum.
- TDMA is more resistant to interference than FDMA.
- TDMA allows for more flexible channel allocation.
- TDMA is more resistant to fading than FDMA.
- TDMA allows for more efficient use of the spectrum.
- TDMA is more resistant to interference than FDMA.
- TDMA allows for more flexible channel allocation.
- TDMA is more resistant to fading than FDMA.

**Disadvantages**

- TDMA requires more complex receivers and transmitters than FDMA.
- TDMA is more susceptible to synchronization errors than FDMA.
- TDMA is more susceptible to timing errors than FDMA.
- TDMA is more susceptible to frequency offsets than FDMA.
- TDMA is more susceptible to Doppler shifts than FDMA.

TDMA allows a mobile station's radio component to listen and broadcast only in its assigned time slot. During the remaining time period, the mobile station may apply network measurements by detecting surrounding transmitters in different frequencies.

This feature allows interfrequency handover, which differs from code division multiple access (CDMA), where frequency handover is difficult to achieve. However, CDMA allows handoffs, which enable mobile stations to simultaneously communicate with up to six base stations.

TDMA is used in most 2G cellular systems, while 3G systems are based on CDMA. However, TDMA remains relevant to modern systems. For example, combined TDMA, CDMA and time division duplex (TDD) are universal terrestrial radio access (UTRA) systems that allow multiple users to share one time slot.

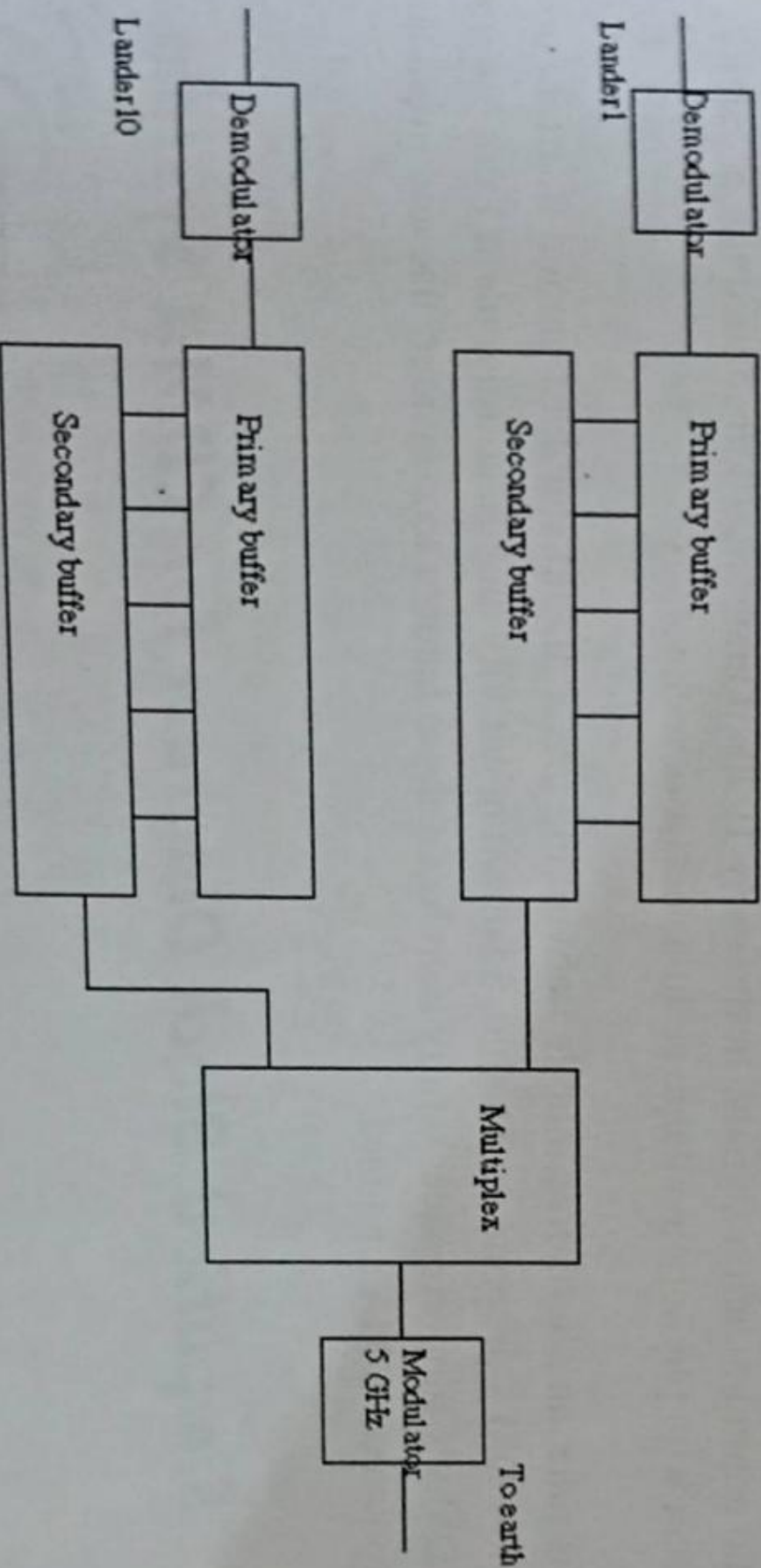

**Advantages of TDMA:**

- TDMA can easily adapt to transmission of data as well as voice communication.
- TDMA has an ability to carry 64 kbps to 120 Mbps of data rates.
- TDMA allows the operator to do services like fax, voice band data, and SMS as well as bandwidth-intensive application such as multimedia and videoconferencing.
- Since TDMA technology separates users according to time, it ensures that there will be no interference from simultaneous transmissions.
- TDMA provides users with an extended battery life, since it transmits only portion of the time during conversations.
- TDMA is the most cost effective technology to convert an analog system to digital.

**Disadvantages of TDMA:**

- Disadvantage using TDMA technology is that the users has a predefined time slot. When moving from one cell site to other, if all the time slots in this cell are full the user might be disconnected.
- Another problem in TDMA is that it is subjected to multipath distortion. To overcome this distortion, a time limit can be used on the system. Once the time limit is expired the signal is ignored
- Code Division Multiple Accessing

### (CDMA) & ITS ADVANTAGES & DIS-ADVANTAGES.

Code division multiple access (CDMA) is a digital cellular network standard that utilizes spread-spectrum technology. This technology does not restrict bandwidth's digital signals or frequencies but spread over a fully-available spectrum or across multiple channels via division.

Thus, there is improved voice and data communication capability and a more secure and private line. CDMA digital standard is a leading communications network standard in North America and parts of Asia. Qualcomm, a US-based wireless communications company, patented CDMA and commercialized this technology.

CDMA technology was initially used in World War II military operations to thwart enemy attempts to intercept radio communication signals. In the early 1990s, Qualcomm introduced the possibility of using the same concept with publicly-available cellular network technology.

During this time, an alternative mobile networking arena digital standard gained traction, proving to be a challenge to CDMA proponents. Despite adamant negativity and discouragement from prominent industry figures, CDMA's supporters successfully convinced these leaders to consider, use and eventually accept the newly introduced CDMA standard.

### **Simplified Block Diagram for CDMA System**

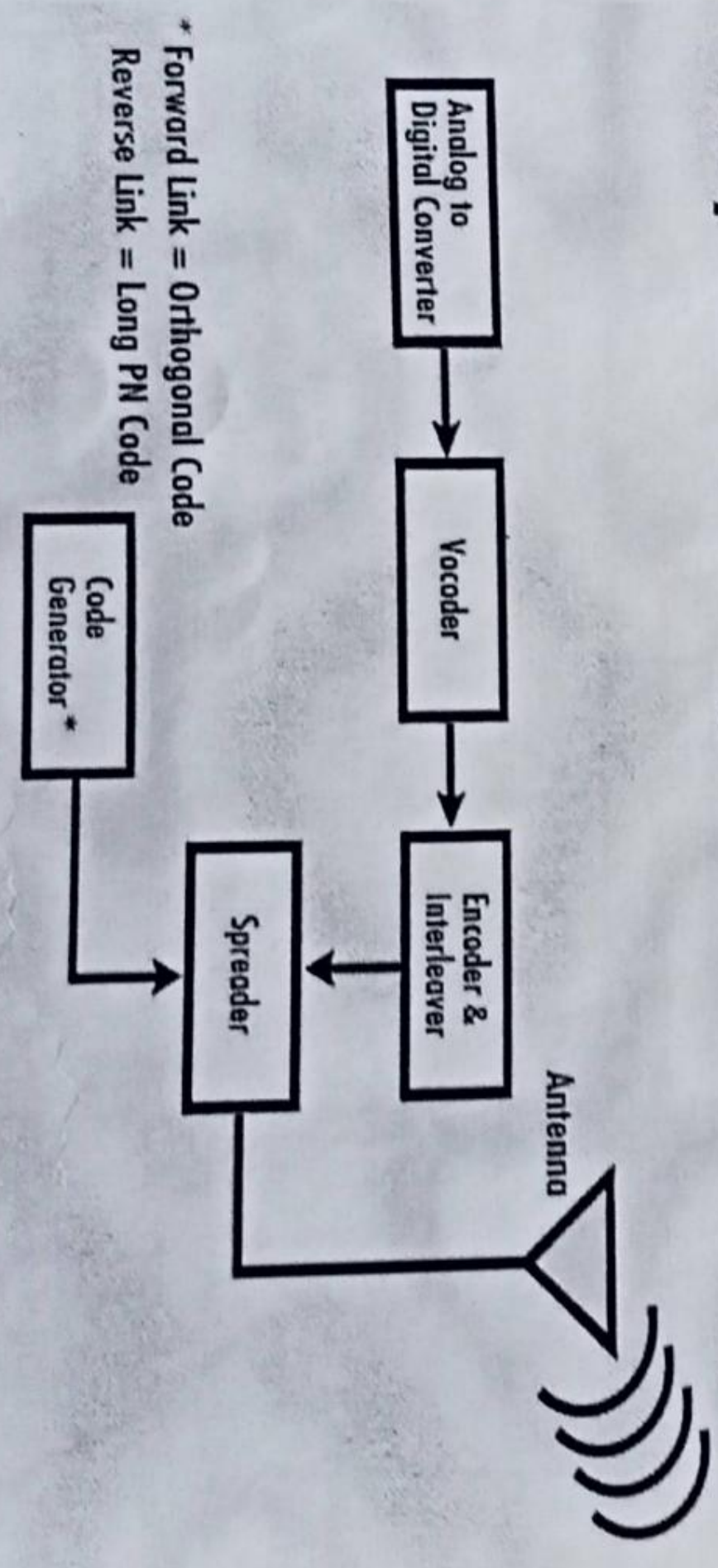

Essentially, CDMA offers more airspace capacity than the time division multiple access (TDMA) has. Another advantage boasted by CDMA technology is its ability for soft handoffs between base stations, i.e., less likelihood of cut-off calls. The usual analogy given in comparing CDMA with other channel access methods like FDMA or TDMA is that of people each carrying out a conversation with a friend in a crowded room. The room, in this case, represents a channel (a.k.a. carrier frequency).

TDMA is likened to the method by which communication is carried out by speaking one at a time (hence the name 'time division'). FDMA, on the other hand, is likened to the method wherein communication is made by speaking at different pitches (hence, frequency division).

Finally, CDMA is likened to people speaking simultaneously but in different languages. Because only those who speak the same language can understand each other, it is possible for multiple conversations to take place in the room at the same time. The basic concept in CDMA is that users who wish to communicate through it are given a shared code.

While multiple codes may occupy the same channel, only those users having the same code can communicate with each other. Because CDMA and GSM standards each have unique pros and cons, the preferred technology standard choice is now in the hands of potential subscribers.

**Advantages of CDMA:**

- One of the main advantages of CDMA is that dropouts occur only when the phone is at least twice as far from the base station. Thus, it is used in the rural areas where GSM cannot cover.
- Another advantage is its capacity; it has a very high spectral capacity that it can accommodate more users per MHz of bandwidth.

**Disadvantages of CDMA:**

- Channel pollution, where signals from too many cell sites are present in the subscriber's phone but none of them is dominant. When this situation arises, the quality of the audio degrades.
- When compared to GSM is the lack of international roaming capabilities.
- The ability to upgrade or change to another handset is not easy with this technology because the network service information for the phone is put in the actual phone unlike GSM which uses SIM card for this.
- Limited variety of the handset, because at present the major mobile companies use GSM technology.

**2.9 Satellite Application- Communication .Satellite, Digital Satellite Radio.**

**Communication Satellite**

It is difficult to go through a day without using a communications satellite at least once. Do you know when you used a communications satellite today? Did you watch T.V.? Did you make a long distance phone call, use a cellular phone, a fax machine, a pager, or even listen to the radio? Well, if you did, you probably used a communications satellite, either directly or indirectly.

Communications satellites allow radio, television, and telephone transmissions to be sent live anywhere in the world. Before satellites, transmissions were difficult or impossible at long distances.

The signals, which travel in straight lines, could not bend around the round Earth to reach a destination far away. Because satellites are in orbit, the signals can be sent instantaneously into space and then redirected to another satellite or directly to their destination.

The satellite can have a passive role in communications like bouncing signals from the Earth back to another location on the Earth; on the other hand, some satellites carry electronic devices called **Transponders** for receiving, amplifying, and re-broadcasting signals to the Earth.



# [CHAPTER-IV]

## TELECOMMUNICATION SYSTEM (Telephone Set)

### 4.1 The operation of Electronic Telephone System, (Telephone Set)

#### The Basic Telephone Set Fundamental Functions

- The basic telephone set connected to the telephone network we are all very comfortable with with has 4 basic functions:
- To provide a signal to the telephone company that a call is to be made (off-hook) or a call is complete (on-hook).
- To provide the telephone company with the number the caller wishes to call.
- To provide a way for the telephone company to indicate that a call is coming in or ringing.
- To convert voice frequencies to electrical signals that can be transmitted at the transmitter and convert those electrical signals back to voice frequencies at the receiver.

The Federal Communications Commission (FCC) has set standards for the above features and manufacturers selling telephones in this country must match these standards or the phone will not work properly.

In addition many modern telephones also come with features like speed dial, redial, memory, caller ID voice mail, etc. These are all additional features that are not necessary to make or receive calls.

Let's look at Telephone Set Function 1: To provide a signal to the telephone company that a call is to be made (off-hook) or a call is complete (on-hook).

The switchhook gets its name from the old telephones that had a hook on the side. On modern phones the switchhook is a button that is depressed when the handset is put on the cradle of the telephone.

According to Telephone Company specifications individual telephone set DC resistance should be 200Ω but in reality most telephones range between 150 and 1000 Ω of DC resistance.

When a user picks up a connected telephone handset to make a call the switch hooks in the figure below (S<sub>1</sub> and S<sub>2</sub>) close (off-hook condition) and the local loop circuit is complete.

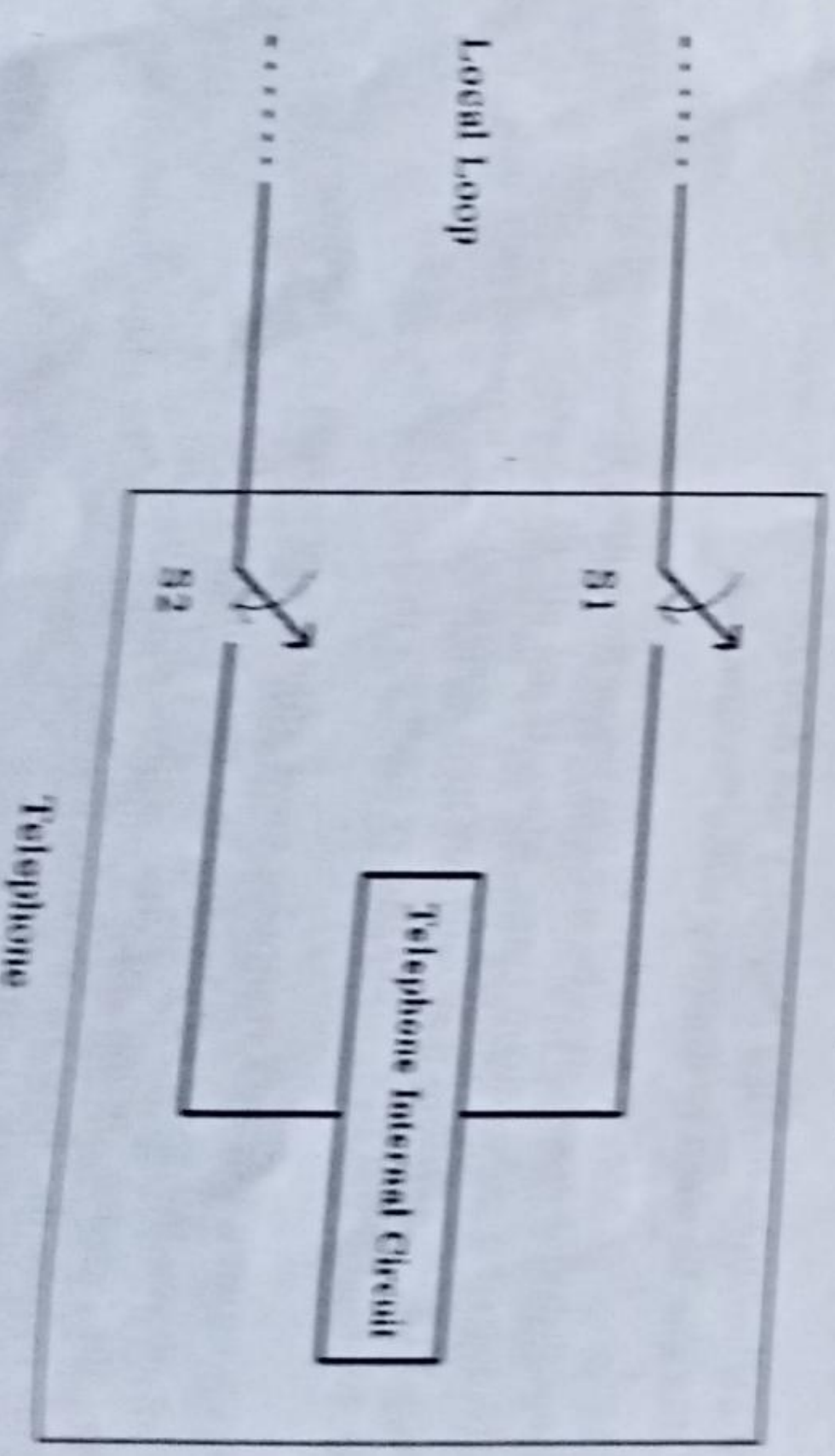

When a handset is picked up, a DC current ranging between 20 and 120 mA flows on the pair of wires connecting the telephone to the CO. This current flow causes a relay coil to magnetize and its contacts close.

In the CO current flows through a relay coil attached to the local loop wire pair. The coil energizes, its contacts close and the CO switch knows a phone is off hook somewhere.

A line feeder in the CO switch looks for the off-hook signal, finds it and sets up a connection. In the CO switch a dial-tone generator is connected to the line so the caller knows they can dial a number.

## 4.2 The function of Switching System & Call Procedures

### Switching system

When there are many devices, it is necessary to develop suitable mechanism for communication between any two devices. One alternative is to establish point-to-point communication between each pair of devices using **mesh topology**.

However, mesh topology is impractical for large number of devices, because the number of links increases exponentially  $(n(n-1)/2)$ , where  $n$  is the number of devices with the number of devices. A better alternative is to use switching techniques leading to switched communication network.

In the **switched network methodology**, the network consists of a set of interconnected nodes, among which information is transmitted from source to destination via different routes, which is controlled by the switching mechanism. A basic model of a switched communication is shown in Fig. 4.1.1.

The end devices that wish to communicate with each other are called *stations*. The switching devices are called *nodes*. Some nodes connect to other nodes and some are to connected to some stations.

Key features of a switched communication network are given below:

- Network Topology is not regular.
- Uses FDM or TDM for node-to-node communication.
- There exist multiple paths between a source-destination pair for better network reliability.
- The switching nodes are not concerned with the contents of data.
- Their purpose is to provide a switching facility that will move data from node to node until they reach the destination.

The switching performed by different nodes can be categorized into the following three types:

- ↓ Circuit Switching
- ↓ Packet Switching
- ↓ Message Switching

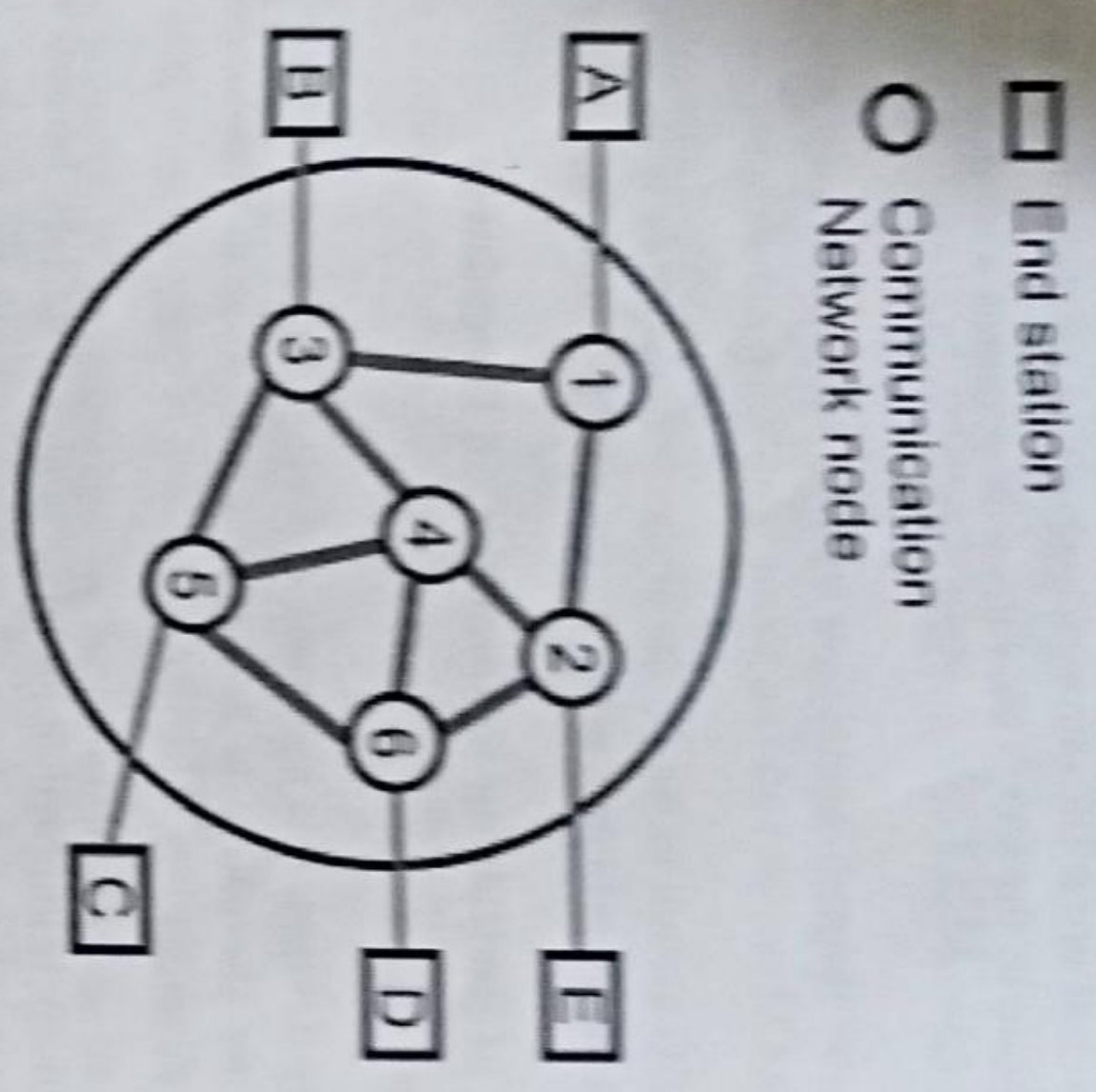

**Basic Call Procedure:**

Fig. Shows a simplification diagram illustrating how two telephone sets (subscribers) are interconnected through a central office dial switch. Each subscriber is connected to the switch through a local loop. The switch is most likely some sort of an electronic switching system (ESS machine). The local loop are terminated at the calling and called station s in telephone sets and at the central office ends to switching machines.

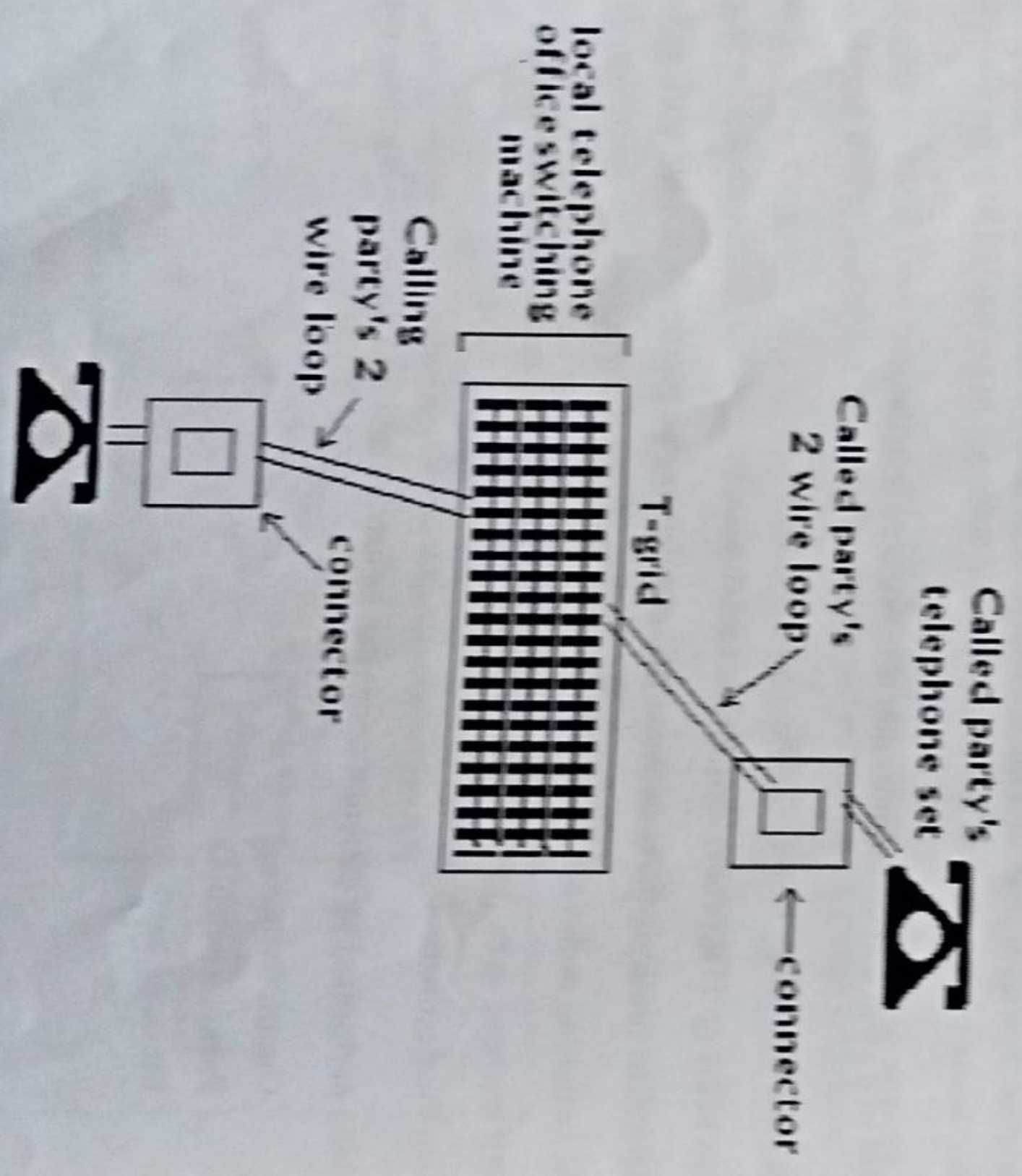

**FIG - Telephone Call Procedure**

When the calling party's telephone set goes off hook (i.e., lifting the handset off the cradle), the switch hook in the telephone set is released, completing a dc path between the tip and the ring of the loop through the microphone.

The ESS machine senses a dc current in the loop and recognizes this as an off-hook condition. Completing a local telephone call between two subscribers connected to the same telephone switch is accomplished through a standard set of procedure that includes the 10 steps listed next.

1. Calling station goes off hook.
2. After detecting a dc current flow on the loop, the switching machine returns an audible dial tone to the calling station, acknowledging that the caller has access to the switching machine.
3. The caller dials the destination telephone number using one of the two methods: Mechanical dial pulsing or, more likely, electronic dual-tone multi frequency (Touch-Tone) signals.
4. When the switching machine detects the first dialed number, it removes the dial tone from the loop.
5. The switch interprets the telephone number and then locates the loop for the destination telephone number.
6. Before ringing the destination telephone, the switching machine tests the destination loop for dc current to see if it is idle (on hook) or in use (off hook). At the same time, the switching machine locates a signal path through the switch between the two local loops.
7. (a) If the destination telephone is off hook, the switching machine sends a station busy signal back to the calling station.  
(b) If the destination telephone is on hook, the switching machine sends a ringing signal to the destination telephone on the local loop and the same time sends a ring back signal to the calling station to give the caller some assurance that something is happening.
8. When the destination answers the telephone, it completes the loop, causing dc current to flow.
9. The switch recognizes the dc current as the station answering the telephone. At this time, the switch removes the ringing and ring-back signals and completes the path through the switch, allowing the calling and called parties to begin conversation.
10. When either end goes on hook, the switching machine detects an open circuit on that loop and then drops the connections through the switch.

### 4.3 The principle of space and time switching.

#### Space Switching

Circuit switching uses any of the three technologies: **Space-Division** switches, **Time-Division** switches or a **Combination of both**.

In Space-division switching, the paths in the circuit are separated with each other spatially, i.e. different ongoing connections, at a same instant of time, uses different switching paths, which are separated spatially.

This was originally developed for the analog environment, and has been carried over to the digital domain. Some of the space switches are crossbar switches, Multi-stage switches (e.g. Omega Switches).

A **Crossbar** switch is shown in Fig. Basic building block of the switch is a metallic crosspoint or semiconductor gate that can be enabled or disabled by a control unit.

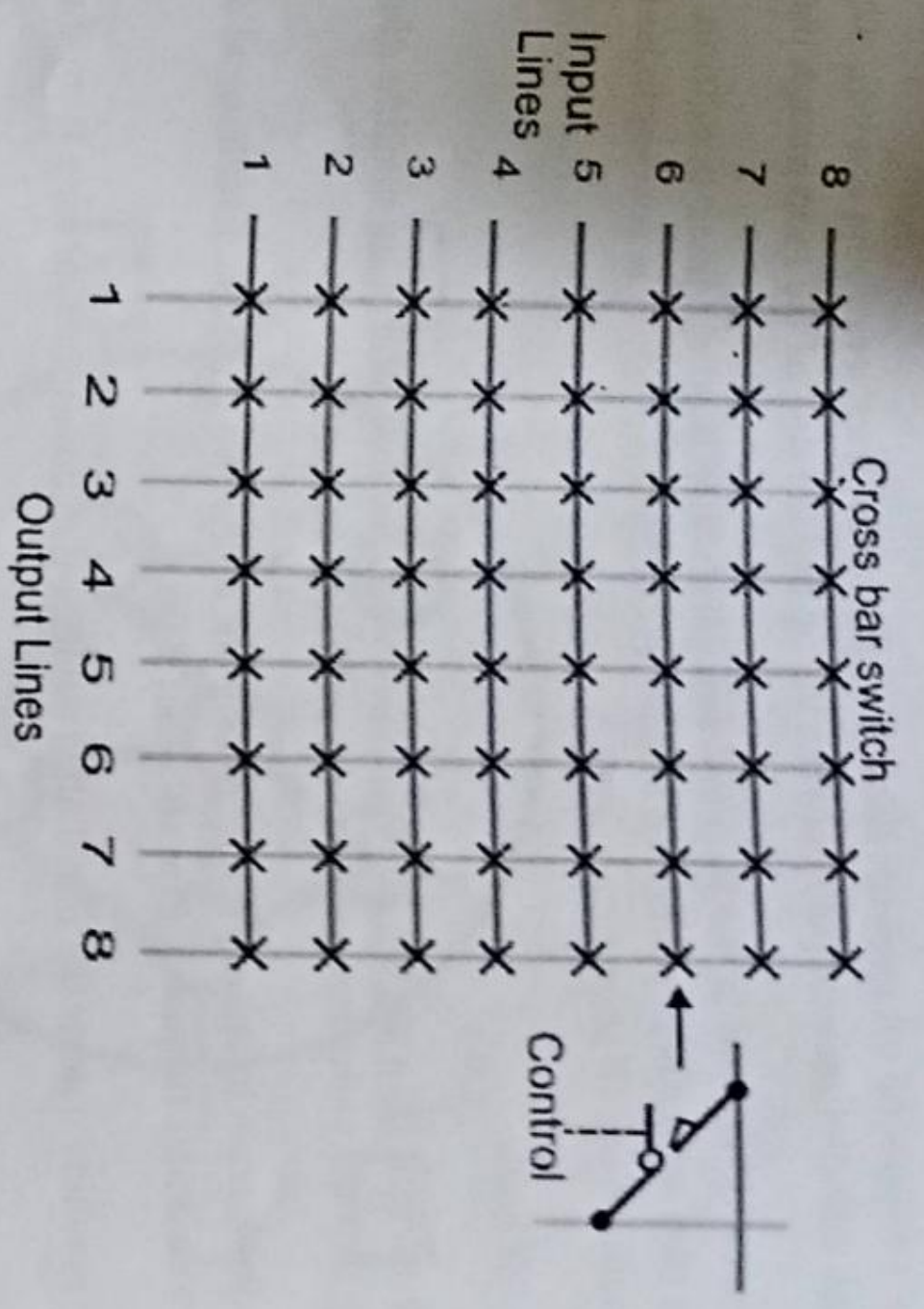

[Figure Schematic diagram of a crossbar switch]

Limitations of crossbar switches are as follows:

- The number of cross points grows with the square of the number of attached stations.
- Costly for a large switch.
- The failure of a cross point prevents connection between the two devices whose lines intersect at that cross point.
- The cross points are inefficiently utilized.
- Only a small fraction of cross points are engaged even if all of the attached devices are active. Some of the above problems can be overcome with the help of *multistage space division switches*.
- By splitting the crossbar switch into smaller units and interconnecting them, it is possible to build multistage switches with fewer cross points.

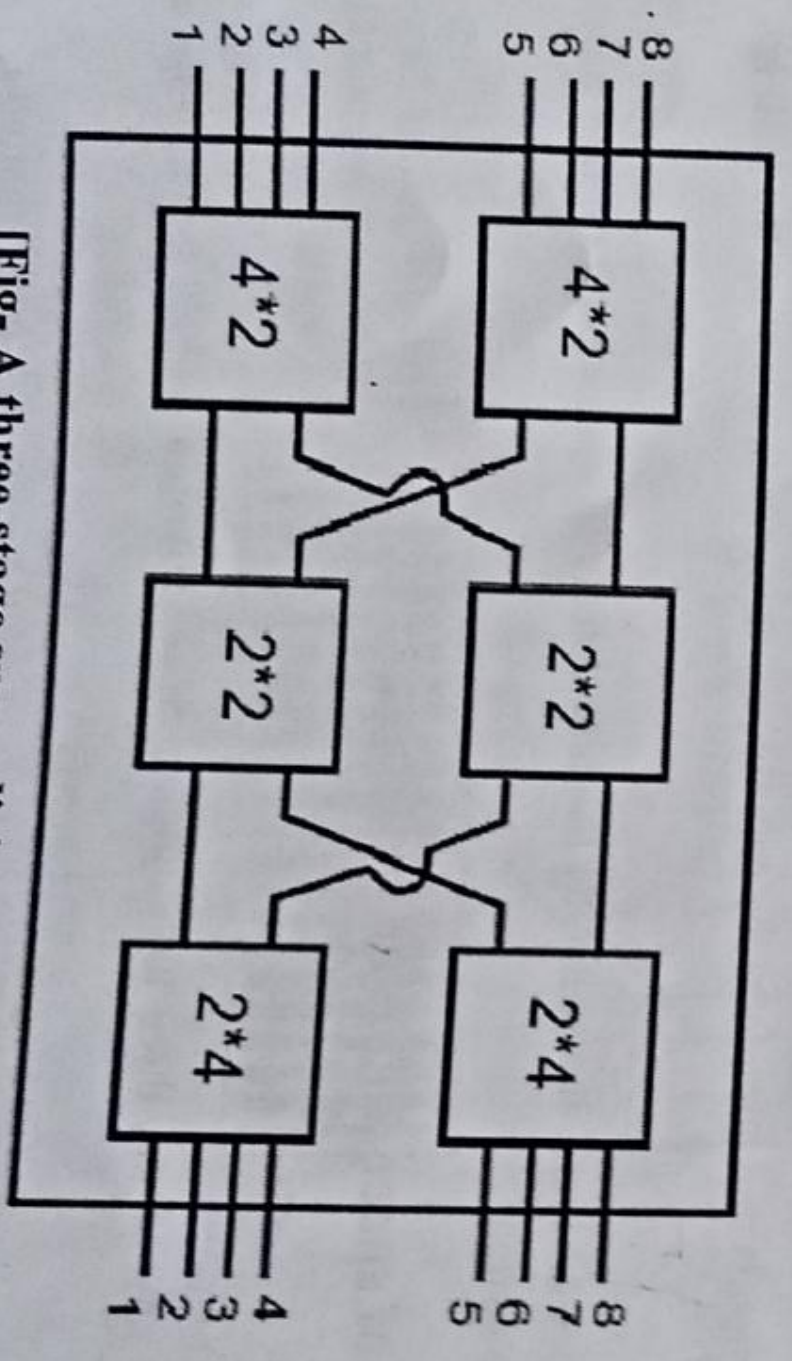

[Fig- A three-stage space division switch]

Figure shows a three-stage space division switch. In this case the number of crosspoints needed goes down from 64 to 40. There is more than one path through the network to connect two endpoints, thereby increasing reliability. Multistage switches may lead to *blocking*.

The problem may be tackled by increasing the number or size of the intermediate switches, which also increases the cost. The blocking feature is illustrated in Fig. 4.1.6. As shown in Fig. 4.1.6, after setting up connections for 1-to-3 and 2-to-4, the switch cannot establish connections for 3-to-6 and 4-to-5.

### Time Division Switching

Both voice and data can be transmitted using digital signals through the same switches. All modern circuit switches use digital time-division multiplexing (TDM) technique for establishing and maintaining circuits. Synchronous TDM allows multiple low-speed bit streams to share a high-speed line.

A set of inputs is sampled in a round robin manner. The samples are organized serially into slots (channels) to form a recurring frame of slots.

During successive time slots, different I/O pairings are enabled, allowing a number of connections to be carried over the shared bus. To keep up with the input lines, the data rate on the bus must be high enough so that the slots recur sufficiently frequently.

For 100 full-duplex lines at 19,200 Kbps, the data rate on the bus must be greater than 1.92 Mbps. The source-destination pairs corresponding to all active connections are stored in the control memory.

Thus the slots need not specify the source and destination addresses. Schematic diagram of time division switching is shown in Fig.

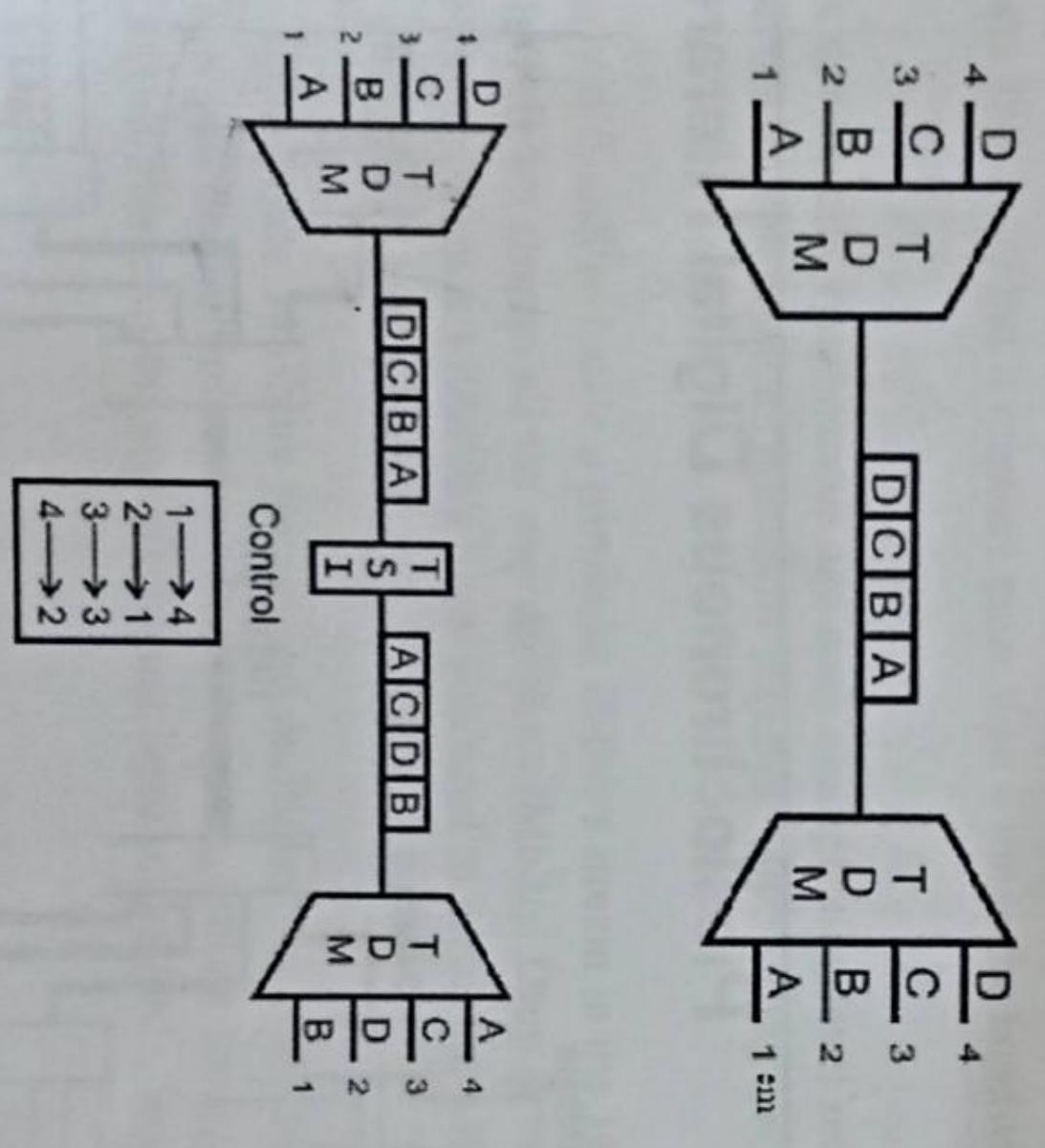

Time-division switching uses time-division multiplexing to achieve switching, i.e. different ongoing connections can use same switching path but at different interleaved time intervals.

There are two popular methods of time-division switching namely, Time-Slot Interchange (TSI) and the TDM bus.

TSI changes the ordering of the slots based on desired connection and it has a random-access memory to store data and flip the time slots as shown in Fig. 4.1.8.

The operation of a TSI is depicted in Fig.1 As shown in the figure, writing can be performed in the memory sequentially, but data is read selectively.

In TDM bus there are several input and outputs connected to a high-speed bus. During a time slot only one particular output switch is closed, so only one connection at a particular instant of time as shown in Fig.2

**The main objectives of the plan are –**

- i) To plan in conformity with relevant and applicable ITU standards to the extent possible.
- ii) To meet the challenges of the changing telecom environment.
- iii) To reserve numbering capacity to meet the undefined future needs.
- iv) To support effective competition by fair access to numbering resources.
- v) To meet subscriber needs for a meaningful and user-friendly scheme. Only the decimal character set 0-9 has been used for all number allocations. Letters and other non-decimal characters shall not form part of the National (Significant) Number [N(S)N]. Dialling procedure as per ITU Recommendation E.164 has been followed.

The Short Distance Charging Area (SDCA) based linked numbering scheme with 10-digit N(S)N has been followed. This would expand the existing numbering capacity to ten times.

**NATIONAL NUMBERING SCHEME**

Level '0':

Sub level '000':

The prefix '000' shall be used for home country direct service (Bilateral) and international toll free service (Bilateral). The format used is: '000 + Country Code + Operator Code' except '000000' which is used for bilateral international toll free service.

Sub level '0010' - INTERNATIONAL CARRIER ACCESS (Prefix) CODE: The prefix '0010' shall be used for selection of international carrier. It will be followed by International Carrier Identification Code (ICIC), Country Code (CC) and N(S)N. The format shall be as under:

Prefix	International Carrier Identification Code	Country Code	National(Significant)Number
0010	ICIC	CC	N(S)N

Initially ICIC shall be a two-digit code. This will be sufficient for allotment to 50 international long distance service providers considering that maximum of two codes may be allotted to each service provider depending upon toll quality and non-toll quality network. However, to take care of all possible future requirements, length of ICIC may be reviewed and changed to 3- digit code as and when required. The allotment of ICIC may start from '10' and codes '00' to '09' may be kept reserved.

**Sub level '00' - INTERNATIONAL PREFIX:**

The prefix '00' shall be used for International dialling. It will be followed by country code and the N(S)N of the country to which that call is attempted. The format is as per ITU Recommendation E.164:

Prefix	Country Code	National(Significant)Number
00	CC	N(S)N

**Sub level '010' - NATIONAL CARRIER ACCESS (Prefix) CODE:**

The prefix '010' shall be used for selection of national long distance carrier. It will be followed by (National) Carrier Identification Code (CIC) and N(S) N. The format shall be as under:

Prefix	Carrier Identification Code	National(Significant)Number
010	CIC	N(S)N

Initially CIC shall be a two-digit code. This will be sufficient for allotment to 40 NLDs (including NLDs licensed for basic services) and 10 BSOs licensed only for basic services, considering that maximum of two codes may be allotted to each service provider depending upon toll quality and non-toll quality network. However to take care of all possible future requirements, length of CIC may be reviewed and changed to 3-digit code in future.

The allotment of CIC may start from '10' and codes '00' to '09' may be kept reserved. For intra circle long distance service, the carrier access code shall be the same as applicable for NLD service. The CIC from '10' to '79' shall be allotted to NLD service providers. For the NLD service providers, who are also Basic Service Operators (BSOs), same CIC shall be applicable for intra circle (service area) calls. CIC from '80' to '99' shall be allocated to the BSOs who are not licensed to provide NLD service.

**4.7 Operation PBX & Digital EPABX.**

**PBX**

**What is a PBX Phone System?**

PBX stands for Private Branch Exchange, which is a private telephone network used within a company or organization. The users of the PBX phone system can communicate within their company or organization and the outside world, using different communication channels like Voice over IP, ISDN or analog. A PBX also allows you to have more phones than physical phone lines (PTSN) and allows free calls between users. It also provides features like transfers, voicemail, call recording, interactive voice menus (IVRs) and ACD call queues.

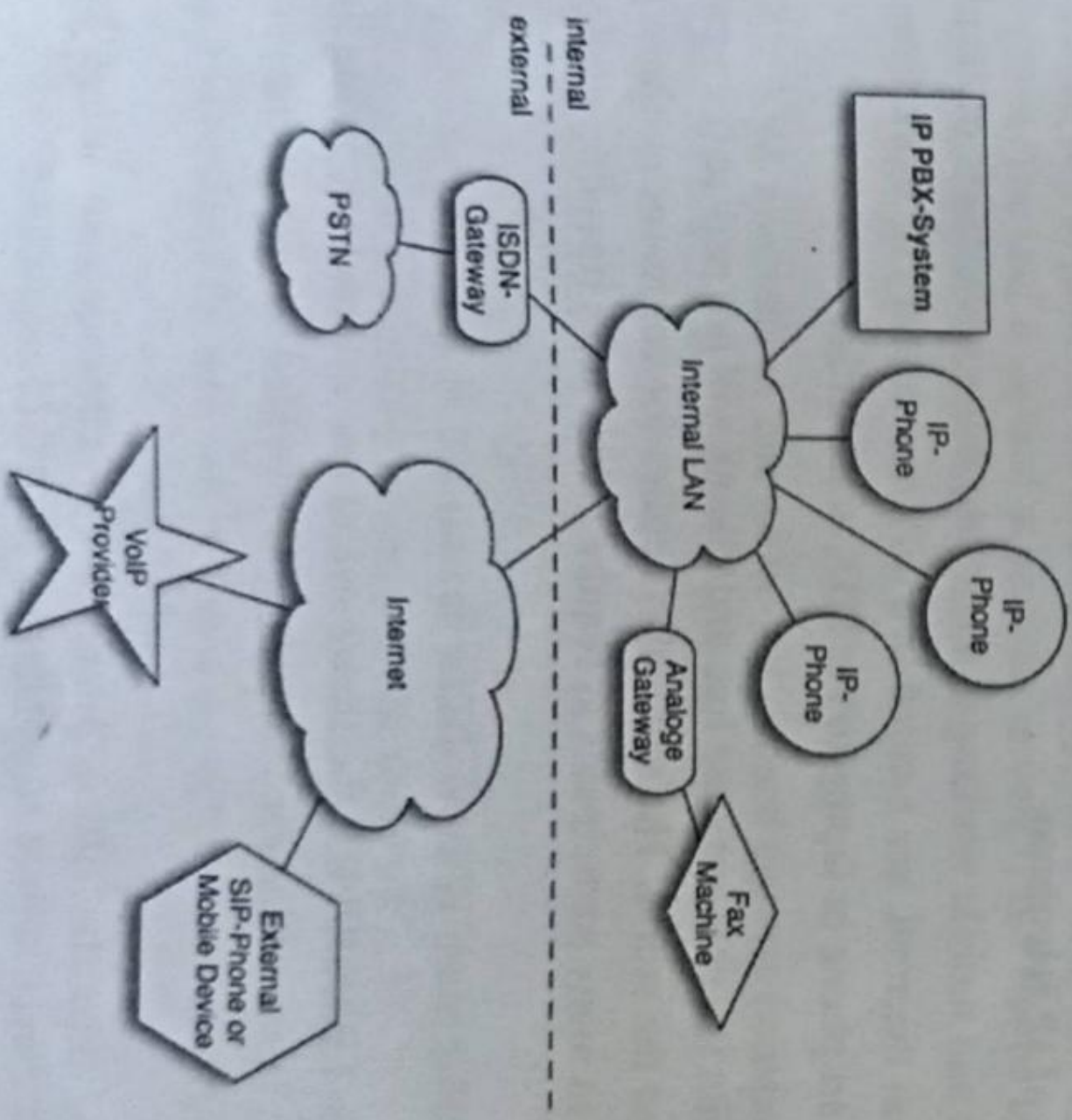



A large residential or commercial building may use several megawatts in electric power and heat. On railways, modern high-powered electric locomotives typically have a peak power output of 5 or 6 MW, although some produce much more.

The Eurostar, for example, uses more than 12 MW, while heavy diesel-electric locomotives typically produce/use 3 to 5 MW. U.S. nuclear power plants have net summer capacities between about 500 and 1300 MW.

The earliest citing of the megawatt in the Oxford English Dictionary (OED) is a reference in the 1900 Webster's International Dictionary of English Language. The OED also states that megawatt appeared in a 28 November 1947 article in the journal Science

#### **Gigawatt**

The gigawatt is equal to one billion (10<sup>9</sup>) watts or 1 gigawatt = 1000 megawatts. This unit is often used for large power plants or power grids. For example, by the end of 2010 power shortages in China's Shanxi province were expected to increase to 5–6 GW and the installed capacity of wind power in Germany was 25.8 GW. The largest unit (out of four) of the Belgian Nuclear Plant Doel has a peak output of 1.04 GW. HVDC converters have been built with power ratings of up to 2 GW.[11] The London Array, the world's largest offshore wind farm, is designed to produce a gigawatt of power

#### **Terawatt**

The terawatt is equal to one trillion (10<sup>12</sup>) watts. The total power used by humans worldwide (about 16 TW in 2006) is commonly measured in this unit. The most powerful lasers from the mid-1960s to the mid-1990s produced power in terawatts, but only for nanosecond time frames. The average lightning strike peaks at 1 terawatt, but these strikes only last for 30 microseconds.

#### **Petawatt**

The petawatt is equal to one quadrillion (10<sup>15</sup>) watts and can be produced by the current generation of lasers for time-scales on the order of picoseconds (10–12 s). One such laser is the Lawrence Livermore's Nova laser, which achieved a power output of 1.25 PW (1.25 × 10<sup>15</sup> W) by a process called chirped pulse amplification. The duration of the pulse was about 0.5 ps (5 × 10<sup>-13</sup> s), giving a total energy of 600 J, or enough energy to power a 100 W light bulb for six seconds

### **4.9 OPERATION AND PRINCIPLE OF Internet Protocol Telephony (IP Telephony)**

Internet Protocol Telephony (IP Telephony) is the use of IP-based networks to build, provide and access voice, data or other forms of telephonic communications. IP telephony provides traditional telephonic communication over an IP-based network, the Internet - via an Internet service provider (ISP) - or directly from a telecommunications service provider.

IP telephony is designed to replace the telecommunications' infrastructure of circuit switched public data networks (CSPDN) and public switched telephone networks (PSTN) with packet switched IP communication networks. In a consumer IP telephony solution, a soft IP phone application and backend Internet connection enable voice and data communication, such as calling and faxing.

A user may call other soft phone users, send or receive faxes and even communicate with circuit switched and cellular communication services. In an enterprise environment, IP telephony is implemented through physical IP phones that work on top of an IP network infrastructure. An IP phone's built-in firmware provides the complete functionality for initiating and managing telephonic communications.

Moreover, IP telephony also supports video communication between two or more users. Voice over Internet Protocol (VoIP), a popular IP telephony implementation, only supports voice communication over IP.

#### How do IP phone systems work?

The "IP" in IP phone system refers to Voice over IP, or having your phone calls routed over the internet or your local network (LAN). This is great for many reasons. First of all, you don't have to use the telephone network of your telephony service provider for making calls, which will reduce your costs for phone calls.

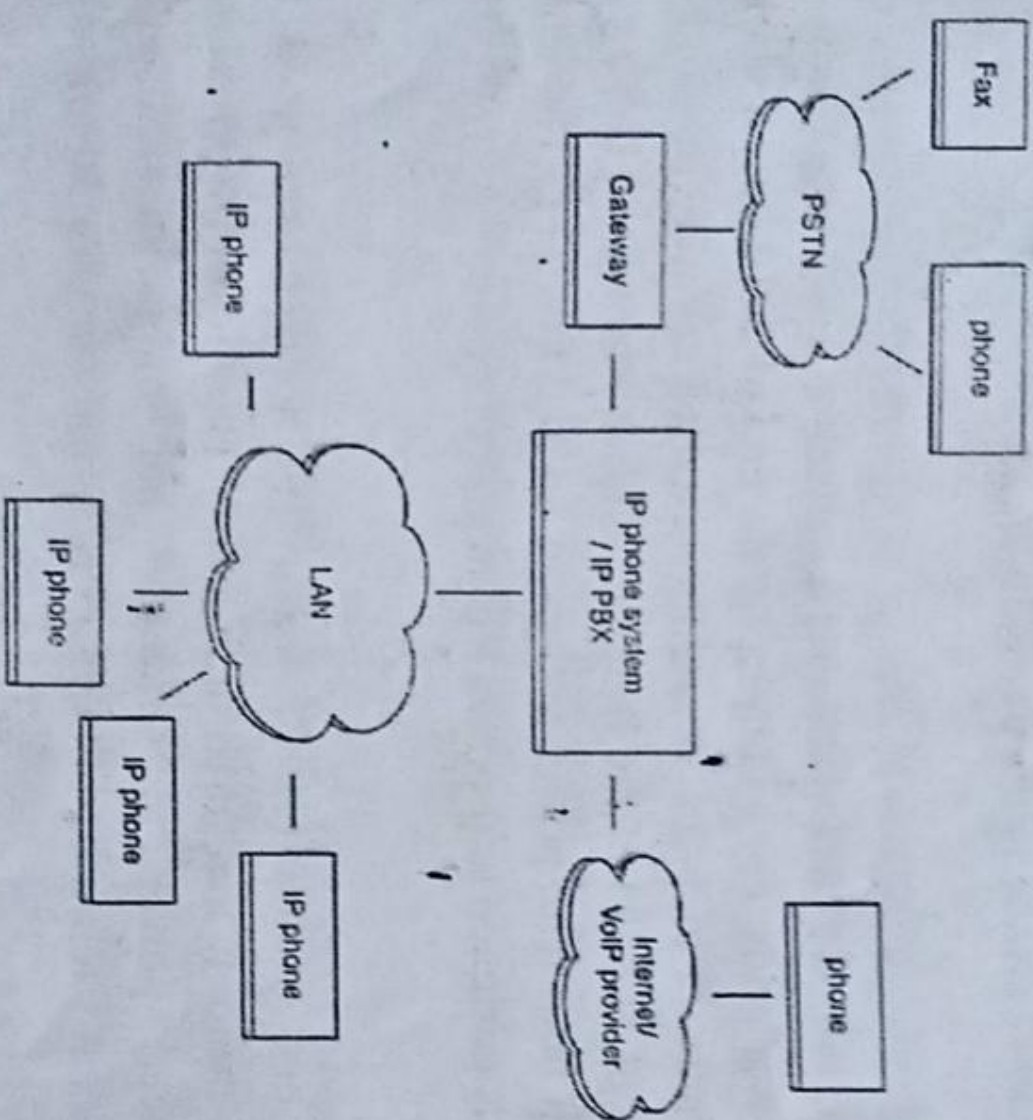

At the same time you are gaining many technical advantages by using IP technology for your telephony. Users of an VoIP phone system simply plug their IP phone into the nearest LAN port. Then, the IP phone registers automatically at the VoIP phone system.

The IP phone always keeps its number, and behaves exactly the same way, no matter where you plug it in — on your desk, in the office next door or on a tropical island. All of this works because of the SIP protocol.

It is a standard widely used by ISPs, VoIP phone systems and VoIP phones world-wide. It makes expensive proprietary phones obsolete, and helps that all devices can talk to each other.

IP phone systems are usually built on standard PC or embedded hardware which are more cost-effective and powerful than the hardware of the traditional phone manufacturers.

At the same time, ip phone systems are scalable, as they are not limited to a certain number of physical phone ports. That means you don't need to replace your phone system when your company grows.

-----ALL THE BEST-----ALL THE BEST-----

→ While an artificial satellite is placed in LEO they travel at about 27400 km/hr (18 km/sec) to complete one revolution around the earth in about 90 min.  
 → LEOs required less powerfull amp<sup>er</sup> for successful transmission as it is used in many communication applications.  
Medium Alt Orbit (MEO): It is also called intermediate circular orbit (geo) lies bet<sup>ween</sup> LEO & GEO  
 → Most common use for satellite in this region is navigat<sup>ion</sup>.  
 → Communication satellite that covers north & south poles are usual<sup>ly</sup> in MEO. The orbital period of MEO satellite range from about (8-18hr)

\* International Band Microwave Band

- ① L → 1-2 GHz
- ② S → 2-4 GHz
- ③ C → 4-8 GHz
- ④ X → 8-12 GHz
- ⑤ Ku → 12-18 GHz (Kunder)
- ⑥ K → 18-27 GHz
- ⑦ Ka → 27-40 GHz (X-above)
- ⑧ millimeter → 40-300 GHz
- ⑨ Submillimeter → > 300 GHz

Ques What is sidereal day?  
 Earth takes ~~24~~<sup>23</sup> hours 56 minutes 4.1 second or around of self. This duration is called 1 sidereal day.

Ques Forward Channel: (down link)  
 The radio channel is used for giving information from base station to mobile station is called forward channel or down link.

Ques Reverse Channel: (uplink)  
 The radio channel is used for transmission of information from mobile station to subscriber is called Reverse channel or uplink.

Ques Roaming:  
 A subscriber which operate under 1 service area can ~~use~~ be subscribe the service of other area, the facility provided by other service area called roaming.

\* Simplex:

It is a 1 direction radio communication, here the subscriber receive but doesn't give any acknowledgment  
Ex: Paging, Radio communication etc.

\* Half Duplex:

It is a 2 directional radio communication but 1 channel is available. So the subscriber either give or receive information at a time  
Ex: Walky talky

\* Full Duplex:

It is a communication system in which simultaneous process of transmission & reception of information can be takes by 2 separate channel.

→ It can be used frequency division duplexing (FDD) & Time division duplexing (TDD)

→ Full duplex & half duplex system use in communication.  
Ex: mobile & telephone.

FDD

→ FDD stands for frequency division duplexing.

TDD

→ TDD stands for time division duplexing.

→ It provide a single antenna duplexer to maintain simultaneous conversation.

→ In this technique, due to this radio channel is divided no. of time slot, a portion of time is used to transmit information from base station to mobile station & remaining all time are used to transmit information from mobile station to base station.

→ It is used for analog communication.  
→ TDD used for digital communication.

\* Layer Used in Mobile Communication:

In mobile communication there are 3 layer are used.

- Physical layer
- Data link layer
- Network layer.

\* Physical Layer:

Actual transmission & reception takes place here.

\* Data Link Layer:

- It deals with <sup>resources</sup> signal at output of base station receiver.
- RADIO <sup>resources</sup> management function such as power control, error control, rate allocation, N/W resource management function such as service scheduling & call admission control takes place here.

\* N/W Layer:

→ It consist of a protocol that include handoff management, traffic management, location management & traffic control.

\* Hand off?

When a mobile station moves from cell to cell its base station changes according to cell without interference by electronic switching unit (ESU) called Hand off.

\* Frequency Reuse:

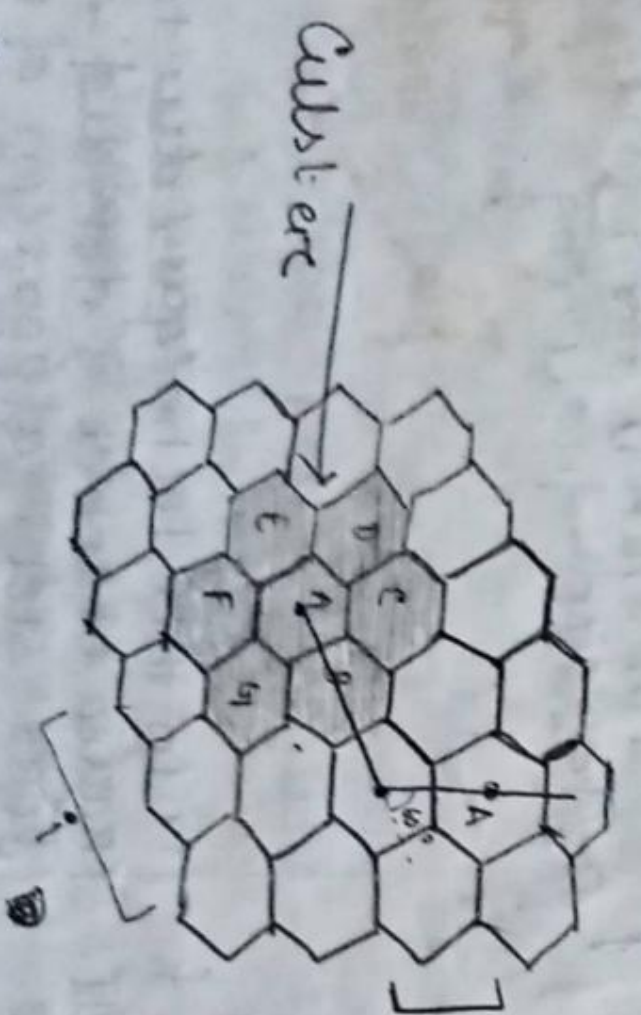

distance between  
A to A → D  
radius A → R

- In mobile communication, for better area coverage the total area is divided into no. of hexagonal cells. Adjacent cell are provided different channel to avoid interference. on the above figure the names A, B, C, D, E, F, G indicate different channel are provided to different adjacent cells.
- These channel (suppose A) can be repeated are reused.
- This technique is called frequency reuse.
- If adjacent cells are called 1 cluster & the size of cluster  $N = i^2 + j^2 + j$  where  $i, j$  are integers,

\* Paging: Paging system is a communication system that sends brief message to the subscriber. The message may be a numeric message, alphanumeric message or voice message.

→ It is a simple system where subscriber can only receive the message, there is no return path to reply directly.

→ In this system full message is called page & this page transmitted throughout the service area using base station which broadcast the page on radio frequency carrier.

→ Paging system may be simple or very complex. It may cover a limited range of area like 2 to 5 km or extend wide coverage area.

→ Through paging receivers are very simple & inexpensive & transmitting system is quite sophisticated which consist of no of telephone line.

Many base station transmitter & large radio towers that simultaneously broadcast a page from each base station.

\* Frequency Reuse Ratio or Channel Reuse Ratio: (CR)

It is defined as ratio of distance between 2 nearby co-channel cell to maximum radius of hexagonal cell.

$$Q = \frac{D}{R}$$

\* Type of interference in mobile communication:

→ Co-channel interference (CAI)

→ Adjacent channel interference (ACI)

\* Importance of National & International Standardization:

→ Interoperability of product & services to customers.

→ Interoperability between products & services made by different vendors.

→ Easier introduction of new product into the national market.

→ Healthy competitiveness among vendors which ultimately reduce cost & improved product quality.

→ Development & innovation according to common guidelines.

→ More accessible service to users/customers.

→ An international interface standard.

→ National standard for port & mod interface & for operation.

→ International standards & agreements for operation.